



## *8 Year Duration*

List of Acceptable Plastics for  
Optical Lenses and Reflex Reflectors  
Used on Motor Vehicles

April 12, 2024



TM

**AMECA**

**8 Year Duration**

**List of Acceptable Plastics for  
Optical Lenses and Reflex Reflectors  
Used on Motor Vehicles**

---

April 12, 2024 Edition

**Automotive Manufacturers Equipment Compliance Agency, Inc.  
1025 Connecticut Avenue, NW Suite #1000  
Washington DC 20036**

**[www.ameca.org](http://www.ameca.org)**

## 1. STATUS

The following materials have been accepted by the Automotive Manufacturers Equipment Compliance Agency as meeting the 8 year version of the weathering test of FMVSS 108. No evaluation has been made as to the suitability of individual materials for particular automotive uses, or to the manufacturing methods.

***You must contact the resin or coating manufacturer to determine the best material for your application.***

***Every plastics resin manufacturer has specialized products for different applications, processing conditions, manufacturing equipment, light sources and final use.***

***Please contact the manufacturer directly for more information.***

The device manufacturers must ensure that the lenses molded from acceptable materials meet the color and plastic stability test requirements for each individual device.

## 2. LISTING

The material is listed by the manufacturer's name, trade name and flow formulation, type of resin, color number and color.

## 3. MATERIAL COATINGS and HAZE

When these materials are used for state/provincial regulated lighting device lenses, the applicable state/provincial regulations shall be met.

## 4. DISTRIBUTION

This list is updated and distributed free on a weekly basis. Any revised or pre-release editions may be obtained by contacting AMECA.

## 5. DEFINITIONS

Coating -- Material applied to surface of the lens to improve some aspect of performance.

Coated materials-- a material which has a coating applied to the surface of the finished sample to impart some protective properties. Coating identification means a mark of the manufacturer's name, formulation designation number, and recommendations for application.

Color bleeding -- the migration of color out of a plastic part onto the surrounding surface.

Cracking -- a separation of adjacent sections of a plastic material with penetration into the specimen.

Crazing -- a network of apparent fine cracks on or beneath the surface of materials.

Delamination -- a separation of the layers of a material including coatings.

Hard Coat -- 1) Coating which is cured by UV radiation.

2) Coating which provides additional resistance to abrasion or scratching which may be cured by thermally or by UV radiation. May contribute to long term durability of material.

**Note:** Both definitions are being used--please verify the intended performance when discussing hard coats.

Haze -- the cloudy or turbid appearance of an otherwise transparent specimen caused by light scattered from within the specimen or from its surface.

UV-protective Coat -- Coating designed to provide additional protection from the sun's electromagnetic radiation, particularly those wavelengths in the UV bandwidth. Often used on polycarbonate substrates to improve weathering performance. Polycarbonates must be coated for use in or in front of reflex reflectors.

Reflex reflectors-- devices used on vehicles to give an indication to approaching drivers using reflected light from the lamps of the approaching vehicle.

Substrate -- Base material to which all other performance enhancing materials are added.

UV radiation -- Short wavelength, high energy radiation emitted by the sun or other object (HID lamp). Wave lengths between 10 and 380 nm.

HID Lamp -- High Intensity Discharge Lamp. Lamps produce light by the use of a stabilized arc. Lamps can produce significant UV radiation which may require special materials. See SAE J1647

## 6. Note ON COLOR

The colors listed have been determined to be in compliance with SAE J-578 using the ASTM E 308-66 method required by FMVSS 108 or in thicknesses specified by the resin manufacturer.

**NOT EVERY COLOR LISTED WILL MEET SAE J-578 COORDINATES  
FOR YOUR INTENDED THICKNESS**

**NOT EVERY MATERIAL IN EVERY COLOR WILL MEET J578 WITH  
LED OR ILLUMINANT C LIGHTSOURCES**

**CHECK WITH THE RESIN MANUFACTURER'S COLOR SPECIALIST**

The ASTM E 308-66 method uses an illuminant A light source energized to 2856k. *If you use anything other than an incandescent light source at 2856k you MUST verify that the resulting color meets the specifications of SAE J-578 for your intended thickness.* Halogen light sources at 3200k, illuminant C (strobe) and LED light sources can dramatically alter the color output. In addition, some light sources do not emit color or luminous flux uniformly. Measurements should be made to verify that the emitted light using your intended lightsource meets the specifications of J-578 throughout its photometric range.

## 7. Note ON INNER LENS COLOR

***Combinations of inner and outer lenses with various colors may not perform predictably. Output can change with different light sources. Check with the resin manufacturer's color specialist when making selections***

## 8. Note ON "EQUIVALENT" FORMULATIONS.

Many companies have distributed manufacturing facilities, cooperative agreements or joint ventures. In order to list a facility or another company the company which has done the FIVE year weathering testing

must send documentation stating that the materials, processes and end products are equivalent between itself and the new applicant. Due to industry complaints, the List of Acceptable Plastics has revised the listing to more accurately reflect the test data from various parent companies. ***In addition, if the joint venture is terminated or the manufacturing facility is sold, the subsidiary or joint company must be able to provide weathering test data on its own. A company can no longer rely on the parent company data and processes if they have no relationship to the parent company who conducted the original testing.***

#### **10. Note ON SUBMITTING FOR ADDITIONAL COLORS**

If you plan to add an additional color number to your listing, please list the existing colors which have undergone the eight year weathering that are a greater and lesser concentration. The colors listed MUST be in the same color space.

#### **11. Note on Inner Lens Testing**

Only inner and outer lens materials, tested together, may be registered for an inner lens system. Not every manufacturer's materials will qualify for the outer lens. Other manufacturers lens material may NOT be used as an outer lens even if those materials have successfully been used as an outer lens for a different material. The inner lens/coating and outer lens/coating must be tested together as a system.

Currently the DOT has issued no guidelines for inner lenses. If and when they do, they will be the requirements that everyone must follow. In the meantime, we would recommend for following guidelines for inner lens test setup.

- 1) You must bracket test every color combination (light/dark) you want to use—red, blue, amber, etc. The light/dark colors must be in the same color space.
- 2) You must bracket test molecular weight (heavy/light) for both outer lens and inner lens.
- 3) The test setup—airspace, ventilation, should duplicate as close as possible the conditions in an inner automotive lens including factors such as ventilation, spacing between inner and outer lens and coatings.
- 4) For more information, please see SAE Paper: <http://papers.sae.org/2004-01-0800>

Inner lens materials will be listed with their outer lens material jointly as a system. Both the inner lens and outer lens material/color will be listed with both materials specified. If you only test a limited range of lens colors, thicknesses or materials that is how they will be listed.

#### **12. Special Note on the definition of “Protected Inner Lens” and/or “Protected Applications”**

**Protected Inner Lenses or Protected Applications for polycarbonate lenses refers to an outer lens which has a UV absorbing capabilities. NOT physical protection but UV protection.**

## Frequently Asked Questions

Q1) If someone else has weathered a polycarbonate/PMMA material, do I have to weather my polycarbonate/PMMA material?

A) Yes, every company's material stands independently from what another company has done. Each coating, pigment and additive must be tested with each company's own material. Each separate material stands alone for weathering performance unless bracketed by materials of higher and lower concentrations or molecular weights.

Q2) If someone else has weathered a pigment with another plastic do I have to weather the pigment with my plastic?

A) Yes, every company's material stands independently from what another company has done. Each coating, pigment and additive must be tested with each company's own material. Each separate material stands alone for weathering performance unless bracketed by materials of higher and lower concentrations or molecular weights.

Q3) If someone else has weathered a coating do I have to weather my material with that coating?

A) Yes, every company's material stands independently from what another company has done. Each coating, pigment and additive must be tested with each company's own material. Each separate material stands alone for weathering performance unless bracketed by materials of higher and lower concentrations or molecular weights.

Q4) Testing laboratories typically use a 1-10 numbering scale according to ASTM D660 to indicate the degree of crazing, cracking or delamination associated with weathering. What numerical value from ASTM D660 is acceptable for listing?

A) FMVSS 108 does not refer to any numerical values from ASTM D660. The numerical values are done by the test laboratory for manufacture convenience.

FMVSS 108 states:

S14.4.2.2.4.2 After completion of the outdoor exposure test materials used for headlamp lenses must show no deterioration.

S14.4.2.2.4.3 After completion of the outdoor exposure test all materials, when compared with the unexposed control samples, must not show physical changes affecting performance such as color bleeding, delamination, crazing, or cracking. **Additionally materials used for reflex reflectors and lenses used in front of reflex reflectors must not show surface deterioration or dimensional changes.**

Your tested samples must not show any changes affecting performance. The only value which shows no change is a numerical value of 10.

Q5) How many thicknesses to I have to test?

A) FMVSS 108: S14.4.2.1.3 Samples must be furnished in thicknesses of  $1.6 \pm 0.25$  mm,  $2.3 \pm 0.25$  mm,  $3.2 \pm 0.25$  mm, and  $6.4 \pm 0.25$  mm.

Q6) Even if it's for a coating?

A) Yes.

Q7) Do materials have to meet the color requirements before testing?

A) Yes: S14.4.2.1.4 All samples must conform to the applicable color test requirement of this standard prior to testing.

Q8) What about the plastics used in non-FMVSS applications such as emergency vehicle lighting which also require three year weathering?

A) Yes, those can be listed with non-standard colors as long as they are NOT used on FMVSS 108 lighting devices.

Testing outline. Note, we also recommend you send DOUBLE samples to prevent any errors.

► 4 Thicknesses

- For each colour
- For each coating
- For each molecular weight (MW)

► For example:

- 4 thickness samples of dark red, uncoated, Lowest MW
- 4 thickness samples of light red, uncoated, Lowest MW
- 4 thickness samples of dark red, uncoated, Highest MW
- 4 thickness samples of light red, uncoated, Highest MW
  
- 4 thickness samples of dark red, coating 1, Lowest MW
- 4 thickness samples of light red, coating 1, Lowest MW
- 4 thickness samples of dark red, coating 1, Highest MW
- 4 thickness samples of light red, coating 1, Highest MW
  
- Now repeat for clear, yellow, blue, coating 2 & coating 3

**AMECA 5 Year Duration**  
**List of Acceptable Plastics for Optical Lenses and Reflex Reflectors**

**Table of Contents**

<b>COVESTRO DEUTSCHLAND AG (EUROPE)</b> .....	<b>9</b>
<b>COVESTRO LLC (AMERICA)</b> .....	<b>9</b>
<b>COVESTRO (HONG KONG) LIMITED (ASIA PACIFIC)</b> .....	<b>9</b>
<b>SABIC USA</b> .....	<b>10</b>
<b>SABIC BRAZIL</b> .....	<b>11</b>
<b>SABIC NANSHA, CHINA</b> .....	<b>12</b>
<b>SABIC SHANGHAI, CHINA</b> .....	<b>13</b>
<b>SABIC EUROPE</b> .....	<b>14</b>
<b>SABIC JAPAN</b> .....	<b>15</b>
<b>SABIC KOREA</b> .....	<b>16</b>
<b>TEIJIN LIMITED</b> .....	<b>17</b>
<b>TEIJIN POLYCARBONATE CHINA LTD.</b> .....	<b>18</b>
<b>TEIJIN POLYCARBONATE SINGAPORE PTE LTD.</b> .....	<b>19</b>
<b>INDEX OF COMPANIES AND MATERIALS</b> .....	<b>20</b>
<b>APPENDIX A: AMECA ACCREDITED LABORATORY INFORMATION</b> .....	<b>21</b>
<b>APPENDIX B: FEDERAL STANDARD AND NOTABLE INTERPRETATION DOCUMENTS FOR PLASTICS</b> .....	<b>22</b>
<b>APPENDIX C: SUPPLEMENTAL LAB INFORMATION</b> .....	<b>24</b>

**Listing of Coating Suppliers**

**KCC Corporation, 9, 10, 11, 12, 13, 14, 15, 16, 17, 18, 19**



<u>MFR.</u>	<u>TRADE NAME and FLOW FORMULATION</u>	<u>TYPE OF RESIN</u>	<u>NUMBER</u>	<u>COLOR</u>
Covestro Deutschland AG (Europe) Covestro LLC (America) Covestro (Hong Kong) Limited. (Asia Pacific)	MAKROLON AL2447 (coated only)	POLYCARBONATE	550396	Clear %
<a href="http://www.covestro.com">www.covestro.com</a>				

Note: KUV-5000 is only listed in 3.2mm thickness.

Coated Covestro Deutschland AG (Europe), LLC and Ltd. Makrolon AL plastics may only be treated with the following acceptable coatings applied to the molded lens:

**Coating in Alphabetical Order and Corresponding Manufacturer**

KUV-5000: See KCC Corporation

**Coating Manufacturer in Alphabetical Order**



Information on, KUV-5000 coatings may be obtained by writing:

KCC Corporation  
83 Mabook-Dong, Giheung-Gu, Yongin-Si  
Gyunggi-Do, South Korea  
[www.kccworld.co.kr](http://www.kccworld.co.kr)

Note: KUV-5000 is only listed in 3.2mm thickness.

Note: All Covestro 8 year weathering data submitted by KCC Corporation

<u>MFR.</u>	<u>TRADE NAME and FLOW FORMULATION</u>	<u>TYPE OF RESIN</u>	<u>NUMBER</u>	<u>COLOR</u>
	SABIC LEXAN® LS-1	POLYCARBONATE	111	White %
	USA LEXAN® LS-2 (Coated Only)			
	<a href="http://www.sabic.com">www.sabic.com</a>			

Note: SABIC LS-1-111 is listed only in 2.3 mm, 3.2 mm and 6.4 mm

Coated SABIC USA plastics may only be treated with the following acceptable coatings applied to the molded lens:

#### Coating in Alphabetical Order and Corresponding Manufacturer

KUV-5000: See KCC Corporation

#### Coating Manufacturer in Alphabetical Order



Information on KUV-5000 coatings may be obtained by writing:

KCC Corporation  
83 Mabook-Dong, Giheung-Gu, Yongin-Si  
Gyeonggi-Do, South Korea  
[www.kccworld.co.kr](http://www.kccworld.co.kr)

Note: SABIC LS-1-111 is listed only in 2.3 mm, 3.2 mm and 6.4 mm

<u>MFR.</u>	<u>TRADE NAME and FLOW FORMULATION</u>	<u>TYPE OF RESIN</u>	<u>NUMBER</u>	<u>COLOR</u>
-------------	----------------------------------------	----------------------	---------------	--------------



SABIC	LEXAN® LS-1	POLYCARBONATE	111 White %
Brazil	LEXAN® LS-2 (Coated Only)		

[www.sabic.com](http://www.sabic.com)

Note: SABIC LS-1-111 is listed only in 2.3 mm, 3.2 mm and 6.4 mm

Coated SABIC Brazil plastics may only be treated with the following acceptable coatings applied to the molded lens:

**Coating in Alphabetical Order and Corresponding Manufacturer**

KUV-5000: See KCC Corporation

**Coating Manufacturer in Alphabetical Order**



Information on KUV-5000 coatings may be obtained by writing:

KCC Corporation  
 83 Mabook-Dong, Giheung-Gu, Yongin-Si  
 Gyunggi-Do, South Korea  
[www.kccworld.co.kr](http://www.kccworld.co.kr)

Note: SABIC LS-1-111 is listed only in 2.3 mm, 3.2 mm and 6.4 mm

<u>MFR.</u>	<u>TRADE NAME and FLOW FORMULATION</u>	<u>TYPE OF RESIN</u>	<u>NUMBER</u>	<u>COLOR</u>
	SABIC LEXAN® LS-1 POLYCARBONATE Nansha LEXAN® LS-2 China (Coated Only)  <a href="http://www.sabic.com">www.sabic.com</a>		111	White %

Coated SABIC Nansha, China plastics may only be treated with the following acceptable coatings applied to the molded lens:

**Coating in Alphabetical Order and Corresponding Manufacturer**

KUV-5000: See KCC Corporation

**Coating Manufacturer in Alphabetical Order**



Information on KUV-5000 coatings may be obtained by writing:

KCC Corporation  
 83 Mabook-Dong, Giheung-Gu, Yongin-Si  
 Gyunggi-Do, South Korea  
[www.kccworld.co.kr](http://www.kccworld.co.kr)

Note: SABIC LS-1-111 is listed only in 2.3 mm, 3.2 mm and 6.4 mm

<u>MFR.</u>	<u>TRADE NAME and FLOW FORMULATION</u>	<u>TYPE OF RESIN</u>	<u>NUMBER</u>	<u>COLOR</u>
-------------	----------------------------------------	----------------------	---------------	--------------



SABIC	LEXAN® LS-1	POLYCARBONATE		111 White %
Shanghai China	LEXAN® LS-2 (Coated Only)			

[www.sabic.com](http://www.sabic.com)

Note: SABIC LS-1-111 is listed only in 2.3 mm, 3.2 mm and 6.4 mm

Coated SABIC Shanghai, China plastics may only be treated with the following acceptable coatings applied to the molded lens:

#### Coating in Alphabetical Order and Corresponding Manufacturer

KUV-5000: See KCC Corporation

#### Coating Manufacturer in Alphabetical Order



Information on KUV-5000 coatings may be obtained by writing:

KCC Corporation  
83 Mabook-Dong, Giheung-Gu, Yongin-Si  
Gyunggi-Do, South Korea  
[www.kccworld.co.kr](http://www.kccworld.co.kr)

Note: SABIC LS-1-111 is listed only in 2.3 mm, 3.2 mm and 6.4 mm

<u>MFR.</u>	<u>TRADE NAME and FLOW FORMULATION</u>	<u>TYPE OF RESIN</u>	<u>NUMBER</u>	<u>COLOR</u>
	SABIC LEXAN® LS-1 Europe White % (Coated Only)	POLYCARBONATE LEXAN® LS-2	111 White % 111S	
	<a href="http://www.sabic.com">www.sabic.com</a>			

Note: SABIC LS-1-111 is listed only in 2.3 mm, 3.2 mm and 6.4 mm

Coated SABIC Europe plastics may only be treated with the following acceptable coatings applied to the molded lens:

**Coating in Alphabetical Order and Corresponding Manufacturer**

KUV-5000: See KCC Corporation

**Coating Manufacturer in Alphabetical Order**



Information on KUV-5000 coatings may be obtained by writing:

KCC Corporation  
 83 Mabook-Dong, Giheung-Gu, Yongin-Si  
 Gyunggi-Do, South Korea  
[www.kccworld.co.kr](http://www.kccworld.co.kr)

Note: SABIC LS-1-111 is listed only in 2.3 mm, 3.2 mm and 6.4 mm

<u>MFR.</u>	<u>TRADE NAME and FLOW FORMULATION</u>	<u>TYPE OF RESIN</u>	<u>NUMBER</u>	<u>COLOR</u>
	SABIC LEXAN® LS-1 Japan LEXAN® LS-2 (Coated Only) <a href="http://www.sabic.com">www.sabic.com</a>	POLYCARBONATE		111 White %

Note: SABIC LS-1-111 is listed only in 2.3 mm, 3.2 mm and 6.4 mm

Coated SABIC Japan plastics may only be treated with the following acceptable coatings applied to the molded lens:

**Coating in Alphabetical Order and Corresponding Manufacturer**

KUV-5000: See KCC Corporation

**Coating Manufacturer in Alphabetical Order**



Information on KUV-5000 coatings may be obtained by writing:

KCC Corporation  
 83 Mabook-Dong, Giheung-Gu, Yongin-Si  
 Gyunggi-Do, South Korea  
[www.kccworld.co.kr](http://www.kccworld.co.kr)

Note: SABIC LS-1-111 is listed only in 2.3 mm, 3.2 mm and 6.4 mm

<u>MFR.</u>	<u>TRADE NAME and FLOW FORMULATION</u>	<u>TYPE OF RESIN</u>	<u>NUMBER</u>	<u>COLOR</u>
	SABIC LEXAN® LS-1 Korea (Coated Only) <a href="http://www.sabic.com">www.sabic.com</a>	POLYCARBONATE LEXAN® LS-2		111 White %

Note: SABIC LS-1-111 is listed only in 2.3 mm, 3.2 mm and 6.4 mm

Coated SABIC Korea plastics may only be treated with the following acceptable coatings applied to the molded lens:

#### Coating in Alphabetical Order and Corresponding Manufacturer

KUV-5000: See KCC Corporation

#### Coating Manufacturer in Alphabetical Order



Information on KUV-5000 coatings may be obtained by writing:

KCC Corporation  
 83 Mabook-Dong, Giheung-Gu, Yongin-Si  
 Gyunggi-Do, South Korea  
[www.kccworld.co.kr](http://www.kccworld.co.kr)

Note: SABIC LS-1-111 is listed only in 2.3 mm, 3.2 mm and 6.4 mm



---

Teijin Limited	Panlite L-1225Z	POLYCARBONATE	100	Clear &
----------------	-----------------	---------------	-----	---------

[www.teijin.co.jp](http://www.teijin.co.jp)

Note: Teijin Panlite L-1225Z-100 is listed only in 2.3 mm and 3.2 mm

### Coating in Alphabetical Order and Corresponding Manufacturer

KUV-5000: See KCC Corporation

### Coating Manufacturer in Alphabetical Order



Information on KUV-5000 coatings may be obtained by writing:

KCC Corporation  
83 Mabook-Dong, Giheung-Gu, Yongin-Si  
Gyeonggi-Do, South Korea  
[www.kccworld.co.kr](http://www.kccworld.co.kr)

Note: Teijin Panlite L-1225Z-100 is listed only in 2.3 mm and 3.2 mm

---

---

Teijin Polycarbonate China Ltd.	Panlite L-1225Z	POLYCARBONATE	100	Clear &
---------------------------------------	-----------------	---------------	-----	---------

[www.teijin.co.jp](http://www.teijin.co.jp)

Note: Teijin Panlite L-1225Z-100 is listed only in 2.3 mm and 3.2 mm

#### **Coating in Alphabetical Order and Corresponding Manufacturer**

KUV-5000: See KCC Corporation

#### **Coating Manufacturer in Alphabetical Order**



Information on KUV-5000 coatings may be obtained by writing:

KCC Corporation  
83 Mabook-Dong, Giheung-Gu, Yongin-Si  
Gyeonggi-Do, South Korea  
[www.kccworld.co.kr](http://www.kccworld.co.kr)

Note: Teijin Panlite L-1225Z-100 is listed only in 2.3 mm and 3.2 mm

---

---

Teijin Polycarbonate Singapore PTE Ltd.	Panlite L-1225Z	POLYCARBONATE	100	Clear &
-----------------------------------------------	-----------------	---------------	-----	---------

[www.teijin.co.jp](http://www.teijin.co.jp)

Note: Teijin Panlite L-1225Z-100 is listed only in 2.3 mm and 3.2 mm

### **Coating in Alphabetical Order and Corresponding Manufacturer**

KUV-5000: See KCC Corporation

### **Coating Manufacturer in Alphabetical Order**

Note: FUJIHARD HH2540U was tested on L1225Z 100M Clear Only.



Information on KUV-5000 coatings may be obtained by writing:

KCC Corporation  
83 Mabook-Dong, Giheung-Gu, Yongin-Si  
Gyeonggi-Do, South Korea  
[www.kccworld.co.kr](http://www.kccworld.co.kr)

Note: Teijin Panlite L-1225Z-100 is listed only in 2.3 mm and 3.2 mm

---

---

## INDEX OF COMPANIES and MATERIALS

### A

Appendix A  
AMECA Accredited Laboratory Information., 21  
Appendix B  
Federal Standard and Notable Interpretation  
Documents For Plastics., 22

### K

KCC Corporation, 9, 10, 11, 12, 13, 14,  
15, 16  
KUV-5000, 9, 10, 11, 12, 13, 14, 15, 16,  
17, 18, 19

### M

MAKROLON, 9

### P

Panlite, 17, 18, 19

### S

SABIC Brazil, 11  
SABIC Europe, 14  
SABIC Japan, 15  
SABIC Korea, 16  
SABIC Nansha, China, 12  
SABIC Shanghai, China, 13  
SABIC USA, 10

### T

Teijin Limited, 17  
Teijin Polycarbonate China Ltd., 18  
Teijin Polycarbonate Singapore PTE Ltd.,  
19

## Appendix A: AMECA Accredited Laboratory Information

Arizona Desert Testing  
21212 West Patton Road  
Wittman, Arizona 85361  
**Tel:** (623) 388-9500  
**FAX:** (623) 388-9007  
**Website:** [www.aztest.com](http://www.aztest.com)

Q-Lab Arizona Test Services  
24742 West Durango Street  
Buckeye, Arizona 85326  
**Tel:** (623) 386-5140  
**FAX:** (623) 386-5143  
**Website:** [www.q-lab.com](http://www.q-lab.com)

Atlas Weathering Services Group  
DSET Laboratories  
45601 N. 47th Avenue  
Phoenix, Arizona 85027-7042  
**Tel:** (623) 465-7356; (800) 255-DSET  
**FAX:** (623) 465-9409  
**Website:** [www.atlaswsg.com](http://www.atlaswsg.com)

Q-Lab Florida Test Services and  
1005 S.W. 18th Avenue,  
P.O. Box 349490  
Homestead, Florida 33034  
**Tel:** (305) 245-5600  
**FAX:** (305) 245-5656  
**Website:** [www.q-lab.com](http://www.q-lab.com)

Atlas Weathering Services Group  
South Florida Test Services  
Everglades Division  
16100 S.W. 216th Street  
Miami, Florida 33170  
**Tel:** (305) 245-3659  
**FAX:** (305) 245-9122  
**Website:** [www.atlaswsg.com](http://www.atlaswsg.com)

## Appendix B: Federal Standard and Notable Interpretation Documents For Plastics

### Excerpts from Section 14 from FMVSS 108

S14.1.2 *Plastic optical materials.* All plastic materials used for optical parts such as lenses and reflectors on lamps or reflective devices required or allowed by this standard must conform to the material test requirements of S14.4.2.

S14.1.3 All coatings used on optical materials must have added to their formulations an optical brightener, whose presence is detectable by ultraviolet light, to aid in testing for their presence. Other equivalent industry accepted methods may be used as an alternative

S14.4.2 Plastic optical materials tests. Accelerated weathering procedures are not permitted.

S14.4.2.1 Samples.

S14.4.2.1.1 Samples of materials shall be injection molded into polished metal molds to produce test specimens with two flat and parallel faces. Alternative techniques may be used to produce equivalent specimens.

S14.4.2.1.2 Test specimens shape may vary, but each exposed surface must contain a minimum uninterrupted area of 32 sq cm.

S14.4.2.1.3 Samples must be furnished in thicknesses of  $1.6 \pm 0.25$  mm,  $2.3 \pm 0.25$  mm,  $3.2 \pm 0.25$  mm, and  $6.4 \pm 0.25$  mm.

S14.4.2.1.4 All samples must conform to the applicable color test requirement of this standard prior to testing.

S14.4.2.1.5 A control sample, kept properly protected from influences which may change its appearance and properties of each thickness, must be retained.

S14.4.2.2 Outdoor exposure test.

S14.4.2.2.1 Outdoor exposure tests of 3 years in duration must be made on samples of all materials, including coated and uncoated versions, used for optical parts of devices covered by this standard. Tests are to be conducted in Florida and Arizona.

S14.4.2.2.2 Concentrations of polymer components and additives used in plastic materials may be changed without outdoor exposure testing provided the changes are within the limits of composition represented by higher and lower concentrations of these polymer components and additives previously tested to this section and found to meet its requirements.

S14.4.2.2.3 Procedure.

S14.4.2.2.3.1 One sample of each thickness of each material must be mounted at each exposure site so that at least a minimum uninterrupted area of 32 sq cm of the exposed upper surface of the sample is at an angle of 45° to the horizontal facing south. The sample must be mounted in the open no closer than 30 cm (11.8 in) to its background.

S14.4.2.2.3.2 During the exposure time the samples must be cleaned once every three months by washing with mild soap or detergent and water, and then rinsing with distilled water. Rubbing must be avoided.

S14.4.2.2.4 Performance requirements. Plastic lenses, other than those incorporating reflex reflectors, used for inner lenses or those covered by another material and not exposed directly to sunlight must meet the optical material test requirements when covered by the outer lens or other material.

S14.4.2.2.4.1 After completion of the outdoor exposure test the haze and loss of surface luster as measured by ASTM 1003-92, Haze and Luminous Transmittance of Transparent Plastic, (incorporated by reference, see 571.108 S5.2 of this title) must not be greater than:

(a) 30% for materials used for outer lenses, other than those incorporating reflex reflectors;

(b) 7% for materials used for reflex reflectors and lenses used in front of reflex reflectors.

S14.4.2.2.4.2 After completion of the outdoor exposure test materials used for headlamp lenses must show no deterioration.

S14.4.2.2.4.3 After completion of the outdoor exposure test all materials, when compared with the unexposed control samples, must not show physical changes affecting performance such as color bleeding, delamination, crazing, or

cracking. Additionally materials used for reflex reflectors and lenses used in front of reflex reflectors must not show surface deterioration or dimensional changes.

S14.4.2.2.4.4 After completion of the outdoor exposure test all materials, when compared with the unexposed control samples, must not have their luminous transmittance accordance with ASTM E 308-66 (1973), Spectrophotometry and Description of Color in CIE 1931 System (incorporated by reference, see 571.108 S5.2 of this title) using CIE Illuminant A (2856K).

S14.4.2.2.4.5 After completion of the outdoor exposure test all materials must conform to the color test of this standard in the range of thickness stated by the material manufacturer.

S14.4.2.3 Heat test.

App

S14.4.2.3.1 Procedure. Two samples of each thickness of each material must be supported at the bottom, with at least 51 mm of the sample above the support, in the vertical position in such a manner that, on each side, the minimum uninterrupted area of exposed surface is not less than 3225 sq mm. The samples are placed in a circulating air oven at  $79 \pm 3$  °C for two hours.

S14.4.2.3.2 Performance requirements. After completion of the heat exposure and cooling to room ambient temperature, a test specimen must show no change in shape and general appearance discernable to the naked eye when compared with an unexposed specimen and continue to conform to the applicable color test requirement of this standard.

## Appendix C: Supplemental Lab Information





US 20160161642A1

(19) **United States**

(12) **Patent Application Publication**  
**Dellock et al.**

(10) **Pub. No.: US 2016/0161642 A1**  
(43) **Pub. Date: Jun. 9, 2016**

(54) **HARD-COAT INFUSED POLYCARBONATE HEADLAMP LENS AND RELATED METHOD**

**Publication Classification**

(71) Applicant: **FORD GLOBAL TECHNOLOGIES, LLC**, Dearborn, MI (US)

(51) **Int. Cl.**  
**G02B 1/14** (2006.01)  
**F21S 8/10** (2006.01)  
**B29D 11/00** (2006.01)

(72) Inventors: **Paul Kenneth Dellock**, Northville, MI (US); **Talat Karmo**, Waterford, MI (US); **Stuart C. Salter**, White Lake, MI (US); **Arsen Terjimanian**, Troy, MI (US); **Joseph Myszka**, Livonia, MI (US)

(52) **U.S. Cl.**  
CPC ..... **G02B 1/14** (2015.01); **B29D 11/00009** (2013.01); **B29D 11/00865** (2013.01); **F21S 48/1225** (2013.01); **B29K 2069/00** (2013.01)

(21) Appl. No.: **14/832,454**

(57) **ABSTRACT**

(22) Filed: **Aug. 21, 2015**

**Related U.S. Application Data**

(60) Provisional application No. 62/086,965, filed on Dec. 3, 2014.

A headlamp lens includes a polycarbonate substrate and an infused protective skin covering on at least one surface of the polycarbonate substrate.

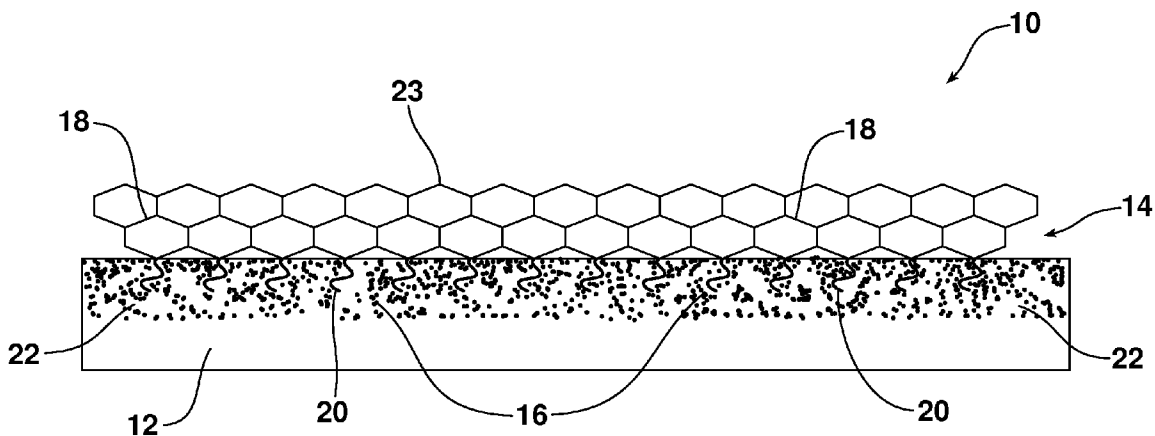
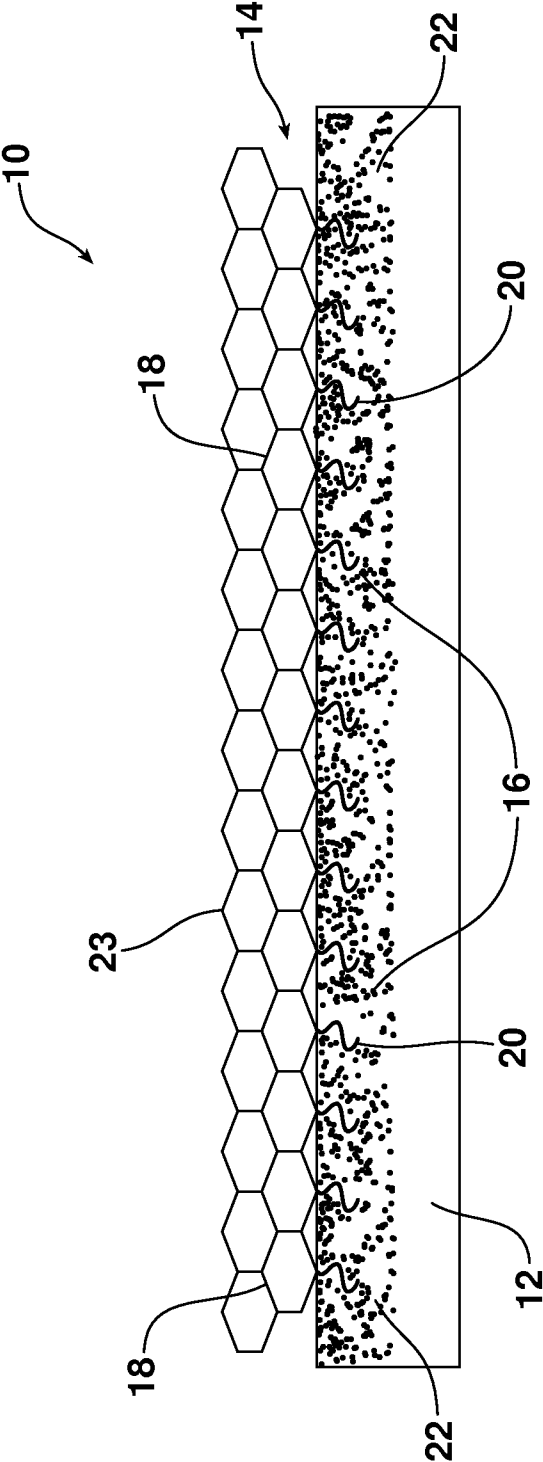

FIG. 1



## HARD-COAT INFUSED POLYCARBONATE HEADLAMP LENS AND RELATED METHOD

[0001] This application claims the benefit of U.S. provisional patent application Ser. No. 62/086,965 filed on 3 Dec. 2014, the full disclosure of which is incorporated herein by reference.

### TECHNICAL FIELD

[0002] This document relates generally to the vehicle equipment field and, more particularly, to a hard-coat infused polycarbonate lens that is less expensive to produce and provides better performance including, particularly, better resistance to UV degradation over time so as to remain clear for the free passage of light for the life of the vehicle.

### BACKGROUND

[0003] Currently, headlamp lenses are molded from optically clear polycarbonate. In order to protect the headlamp lenses from both abrasion and ultraviolet (UV) weathering degradation, a clear silica hard-coat and anti-UV additives are applied to the forward surface of the headlamp. Silica hard-coated polycarbonate headlamp lenses provide excellent resistance to scratches and excellent impact performance. However, silica hard-coated polycarbonate headlamp lenses suffer a number of drawbacks.

[0004] More specifically, the silica hard-coating process is very expensive and typically requires large facility expense in order to implement. Further, exposure to UV radiation from the rays of the sun attacks both the coating and the lens base polycarbonate substrate. Current state-of-the-art UV protection lasts up to 3000 hours of accelerated weathering. However, it should be appreciated that many vehicles including, for example, those in the Sun Belt areas of the United States are exposed to substantial UV radiation that, over time, breaks down the substrate leading to yellowing and clouding which reduces headlamp performance. Further, as the UV rays of the sun degrade the substrate, the silica hard-coat may delaminate from the polycarbonate substrate accelerating the substrate degradation. This also leads to degradation of the impact performance of the lens. Still further, the hard-coat process relies upon volatile organic compounds (VOCs) which are an environmental concern.

[0005] This document relates to a new and improved method that provides similar or improved scratch resistance and significantly better UV performance than found in current polycarbonate headlamp lenses. As a result, impact resistance and clarity may be better maintained for the life of the vehicle. Further, the method utilized to provide this increased performance is more affordable than and does not release VOCs into the atmosphere like the prior art process.

### SUMMARY

[0006] In accordance with the purposes and benefits described herein, a headlamp lens is provided. That headlamp lens comprises a polycarbonate substrate and an infused protective skin covering at least one surface of the polycarbonate substrate.

[0007] In one possible embodiment, the infused protective skin includes a scratch-resistant agent and a UV inhibitor. In one possible embodiment, the scratch-resistant agent is silicone-based. In one possible embodiment, the scratch-resistant agent is selected from a group of materials consisting of

vinyl (mono-, di- and tri-alkoxysilanes), phenyl (mono-, di- and tri-alkoxysilanes), diphenyldialkoxysilanes, vinyltri-alkoxysilanes, and other silicone-based molecules and mixtures thereof.

[0008] In one possible embodiment, the UV inhibitor is selected from a group of materials consisting of benzophenone, a benzotriazole and mixtures thereof. Still further, in one possible embodiment, the infused protective skin further includes a UV stabilizer. In one possible embodiment, that UV stabilizer may be a hindered amine light stabilizer.

[0009] Still further, the polycarbonate substrate in any embodiment may include a plurality of pores. Further, the scratch-resistant agent may comprise silicon-based molecules having relatively large heads and relatively narrow tails wherein the heads rest on a surface of the substrate overlying the pores and the tails penetrate the pores and act as an anchor for the heads.

[0010] In accordance with an additional aspect, a method is provided of manufacturing a polycarbonate headlamp lens with an infused skin providing scratch resistance and UV protection. That method may be described as comprising the steps of molding the headlamp lens substrate from polycarbonate material, cleaning the polycarbonate substrate following molding and infusing a surface of the polycarbonate substrate with a protective skin to produce polycarbonate infused headlamp lenses. This is then followed by rinsing and drying the lenses.

[0011] In one possible embodiment, the method further includes increasing the thickness of the protective skin following infusing. In one possible embodiment, this is done by chemically enhanced physical vapor deposition.

[0012] In one possible embodiment, the method includes incorporating a scratch resistant agent and a UV inhibitor in the protective skin. That scratch resistant agent may be selected from a group of materials consisting of vinyl (mono-, di- and tri-alkoxysilanes), phenyl (mono-, di- and tri-alkoxysilanes), diphenyldialkoxysilanes, vinyltrimethoxysilanes, other silicone-based molecules and mixtures thereof. Further, the method may include selecting the UV inhibitors from a group of materials consisting of benzophenone, a benzotriazole, other UV inhibitor compounds and mixtures thereof. Further, the method may include incorporating one or more UV stabilizers in the protective skin.

[0013] In one possible embodiment, the method includes cooling the headlamp lens substrate after molding and prior to cleaning to a temperature between 65° C. and room temperature. Further, the method includes infusing by dipping the substrate into an infusion tank including an infusion solution bath for a period of time between 10 to 60 seconds at a temperature between 65-90° C. so as to open pores in the substrate to allow superficial infusion of the protective skin to the substrate. In one possible embodiment, the scratch resistant agent and the UV inhibitor are infused in a single step. In another possible embodiment, the scratch resistant agent and the UV inhibitor are infused in multiple steps for the purposes of building up the desired thickness of the hard coating. In addition, the method may include the step of performing a scratch resistance test to select infused lenses and adjusting the concentration of additives in the infusion solution bath as required until the desired results are achieved.

[0014] In the following description there are shown and described several preferred embodiments of the headlamp lens. As should be realized, the headlamp lens is capable of other, different embodiments and its several details are

capable of modification in various, obvious aspects, all without departing from the headlamp lens as described in the following claims.

[0015] Accordingly, the drawings and descriptions should be regarded as illustrative in nature and not as restrictive.

#### BRIEF DESCRIPTION OF THE DRAWING FIGURE

[0016] The accompanying drawing figure incorporated herein and forming a part of the specification, illustrates several aspects of the infused headlamp lens and together with the description serves to explain certain principles thereof.

[0017] FIG. 1 is a schematic representation of the polycarbonate lens with an infused protective coating.

[0018] Reference will now be made in detail to the present preferred embodiments of the headlamp lens, an example of which is illustrated in the accompanying drawing figure.

#### DETAILED DESCRIPTION

[0019] Reference is now made to FIG. 1 illustrating the headlamp lens 10. That headlamp lens 10 comprises a polycarbonate substrate 12 and an infused protective skin 14 covering at least one surface (i.e. the forward surface) of the polycarbonate substrate and an optional PECVD (Plasma Enhanced Chemical Vapor Deposition) build-up.

[0020] In one embodiment, the infused protective skin 14 includes a scratch resistance agent and a UV inhibitor. In one possible embodiment, the scratch resistance agent is silicone-based. Such a scratch resistance agent may be selected from a group of materials consisting of vinyl (mono-, di- and tri-alkoxysilanes), phenyl (mono-, di- and tri-alkoxysilanes), diphenyldialkoxysilanes, vinyltrimethoxysilanes, and other silicone-based molecules and mixtures thereof.

[0021] In one embodiment the UV inhibitor is selected from a group of materials consisting of a benzophenone, a benzotriazole, or other compounds like hydroxyphenyltriazines and mixtures thereof. Further, in one possible embodiment the infused protective skin further includes one or more UV stabilizers. The UV stabilizer may take the form of a hindered amine light stabilizer.

[0022] As illustrated in FIG. 1, in any of the embodiments the polycarbonate substrate 12 includes a plurality of pores 16. In one possible embodiment, the scratch resistance agent comprises silicone-based molecules having relatively large heads 18 and relatively narrow tails 20 wherein the heads rest on a surface of the substrate 12 overlying the pores 16 so as to provide a hard, impact resistant protective coating while the tails 20 penetrate the pores and act as an anchor for the heads. Advantageously, this structure provides a chemical bond between the infused protective skin 14 and the polycarbonate substrate 12 that is (a) far superior to and (b) resists the delamination characteristic of mechanically bonded hard-coats provided on headlamp lenses made in accordance with methods known in the art. It also serves to seal in the UV inhibitor 22 that has penetrated and been deposited deep in other pores 16.

[0023] In accordance with an additional aspect, a method is provided for manufacturing a polycarbonate headlamp lens 10 having a polycarbonate substrate 12 and an infused skin 14 providing scratch resistance and UV protection. That method may be broadly described as comprising the steps of molding the headlamp lens substrate 12 from the polycarbonate mate-

rial, cleaning the polycarbonate substrate following molding, infusing a surface of the polycarbonate substrate with a protective skin 14 and adding an optional PECVD layer 23 to produce an infused headlamp lens 10, rinsing the lens and drying the lens. The method may also include incorporating a scratch resistance agent and a UV inhibitor in the protective skin 14. Further, the method may include selecting a scratch resistance agent from a group of materials consisting of vinyl (mono-, di- and tri-alkoxysilanes), phenyl (mono-, di- and tri-alkoxysilanes), diphenyldialkoxysilanes, vinyltrimethoxysilanes, and other silicone-based molecules and mixtures thereof.

[0024] In addition the method may include the selecting of the UV inhibitor from a group of materials consisting of a benzophenone, a benzotriazole, other compounds like hydroxyphenyltriazines and mixtures thereof. Further the method may include incorporating a UV stabilizer in the protective skin 14.

[0025] Still more specifically, the method may include cooling the headlamp lens substrate 12 after molding and prior to cleaning to a temperature of between 65° C. and room temperature. Further the infusing step may include dipping the substrate 12 into an infusion tank including an infusion solution bath for a period of time of between 10 to 60 seconds at a temperature between 65-90° C. so as to open the pores 16 in the substrate to allow superficial infusion of the protective skin 14 into the substrate. In one possible embodiment, the scratch resistance agent and the UV inhibitor are infused in a single step. In another possible embodiment, the scratch resistance agent and the UV inhibitor are infused in multiple steps. In another embodiment, the method includes performing a scratch resistance test to selected infused lenses and adjusting the concentrations of additives in the infusion solution bath as required until the desired results are achieved.

[0026] Another embodiment is to increase the depth of the silica layer by using an additional deposition process such as PECVD or other deposition process.

[0027] In yet another embodiment, the thickness of the infused skin may be further increased by appropriate physical or chemical conditioning or both. A potential way of achieving this is by chemically enhanced physical vapor deposition (CEPVD). In this technique, the infused polycarbonate is placed inside a chamber where silica and related silicon-based compounds (precursors) are ionized and vaporized under partial vacuum at moderate or near ambient temperatures and the vapors are allowed to deposit and condense onto the infused polycarbonate. Final hard coating thicknesses are controlled by the selection of the type of precursor and the chamber time/temperature/vacuum pressure to which the polycarbonate is exposed. In one possible embodiment, the thickness of the infused protection skin is between 1 and 10 microns. In another possible embodiment the protective skin has a thickness of about 7 microns. Where CEPVD is used to increase the thickness of the protective skin, the infused silica surface is receptive to chemical bonding and physical binding with the vaporized silica and related silicon-based compounds to provide a hard, scratch resistant layer.

[0028] In one possible embodiment, the polycarbonate headlamp lens substrate may be removed from the molding tool using an overhead conveyor transport. The molded lens may then be cooled to a temperature between 65° C. and room temperature by air circulation or other means prior to cleaning. Cleaning may be completed by dipping the lens 10 into a

tank filled with distilled, deionized water for 10 to 30 seconds. That water is maintained at anywhere from room temperature to 65° C.

**[0029]** After cleaning, the lens is dipped into an infusion tank holding an infusion solution bath for from 10 to 60 seconds wherein the bath is held at 65 the 90° C. The bath opens the pores **16** in the surface of the substrate **12** to allow superficial infusion of the additives in the infusion solution to a depth of 0.1-10 $\mu$  or more as desired.

**[0030]** If the scratch resistance agent and the UV inhibitor are infused in a single step, the infusion solution bath includes an aqueous mixture of surface active agents including ionic and nonionic surfactants (emulsifiers). These surfactants hold two or more immiscible liquids, solids and mixtures in suspension. Proper emulsification is essential to the satisfactory performance of the carrier. Emulsifiers can be ionic (anionic, cationic, and amphoteric) and non-ionic.

**[0031]** Sodium stearate (a soap)—is an example of an anionic surfactant;

**[0032]** Trimethylhexadecyl ammonium bromide—is an example of a cationic surfactant;

**[0033]** Cocoamidopropylbentaine—is an example of an amphoteric surfactant; and

**[0034]** Polyethylene ethoxylate—is an example of a non-ionic surfactant.

**[0035]** Additional chemicals in the infusion solution bath may further include ethanol, other solvents, dispersants, plasticizers and leveling agents. If the scratch resistance agent and the UV inhibitor are infused in a single step, the infusion solution bath may further include hard coating materials based on the hard coating formula and the UV protection formula described below. In the event the scratch resistance agent and the UV inhibitor are to be infused in multiple steps, the first infusion path would include either the hard coating formula or the UV protection formula and a second infusion coating bath would include the other of the hard coating formula or UV protection formula.

**[0036]** For purposes of this document the hard coating formula may be described as comprising a number of silicone-based molecules that are suitable for the hard coating infusion of the polycarbonate lens **12**. As previously noted, these may include vinyl (mono-, di- and tri-alkoxysilanes), phenyl (mono-, di- and tri-alkoxysilanes), diphenyldialkoxysilanes, vinyltrimethoxysilane, other silicone-based molecules and mixtures thereof. Such molecules have long chain organic tails **20** that are able to penetrate the polycarbonate pores **16** and act as chemical anchor sites.

**[0037]** For purposes of this document the UV protection formula may be described as including UV absorbers based on conjugated compounds (containing double bonds) that absorb the UV radiation and re-emit it in the lower energy infrared range. These include benzophenones and benzotriazoles. Additionally, the UV protection, may include UV stabilizers. One of the most effective and important stabilizers are the hindered amine light stabilizers (HALS). Rather than simply absorbing the light energy, these stabilizers work by interrupting the photo degradation process before it can get destructively underway. The mechanisms used include “free radical scavenging”, “peroxide decomposition” as well as energy absorption.

**[0038]** With the exception for water and alcohol, concentrations of the various chemicals may range from 0.01% to 10% each by weight or by volume. Concentrations of water and alcohol can range from 10 to 90% by volume.

**[0039]** Rinsing of the lens following infusion may comprise dipping the lens **10** in a second rinse tank of distilled ionized water for 10 to 30 seconds that has a temperature anywhere from room temperature to 65° C. The lens **10** is then removed from the tank and air dried such as by means of a drying fan. After performing any necessary scratch resistance testing on a selected test sample specimen, the remaining lenses **10** in the group of lenses being manufactured together are packaged for shipment. As should be appreciated all the steps may be performed by utilizing a robotic system with precise timing and sequencing protocol. Further, it should be appreciated that the headlamp lenses **10** may be infused at the molding site or at a remote facility any time after molding.

**[0040]** The foregoing has been presented for purposes of illustration and description. It is not intended to be exhaustive or to limit the embodiments to the precise form disclosed. Obvious modifications and variations are possible in light of the above teachings. All such modifications and variations are within the scope of the appended claims when interpreted in accordance with the breadth to which they are fairly, legally and equitably entitled.

What is claimed:

1. A headlamp lens, comprising:  
a polycarbonate substrate; and  
an infused protective skin covering at least one surface of said polycarbonate substrate.
2. The lens of claim 1, wherein said infused protective skin includes a scratch resistance agent and a UV inhibitor.
3. The lens of claim 2, wherein said scratch resistance agent is silicone based.
4. The lens of claim 3, wherein said scratch resistance agent is selected from a group of materials consisting of vinyl (mono-, di- and tri-alkoxysilanes), phenyl (mono-, di- and tri-alkoxysilanes), diphenyldialkoxysilanes, vinyltrimethoxysilane, other silicone-based molecules and mixtures thereof.
5. The lens of claim 4, wherein said UV inhibitor is selected from a group of materials consisting of a benzophenone, a benzotriazole, a hydroxyphenyltriazine, and mixtures thereof.
6. The lens of claim 5, wherein said infused protective skin further includes a UV stabilizer.
7. The lens of claim 6, wherein said UV stabilizer is a hindered amine light stabilizer.
8. The lens of claim 3, wherein said polycarbonate substrate includes a plurality of pores.
9. The lens of claim 8, wherein said scratch resistance agent comprises silicone based molecules having relatively large heads and relatively narrow tails wherein said heads rest on a surface of said substrate overlying said pores and said tails penetrate said pores and act as an anchor for said heads.
10. A method of manufacturing a polycarbonate headlamp lens with an infused skin providing scratch resistance and UV protection, comprising:  
molding said headlamp lens substrate from polycarbonate material;  
cleaning said polycarbonate substrate following molding;  
infusing a surface of polycarbonate substrate with a protective skin to produce polycarbonate infused headlamp lens;  
rinsing said lens; and  
drying said lens.
11. The method of claim 10, further including increasing thickness of said protective skin following infusing.

**12.** The method of claim **11**, including increasing thickness of said protective skin by chemically enhanced physical vapor deposition.

**13.** The method of claim **11**, including incorporating a scratch resistance agent and a UV inhibitor in said protective skin.

**14.** The method of claim **13**, including selecting said scratch resistance agent from a group of materials consisting of vinyl (mono-, di- and tri-alkoxysilanes), phenyl (mono-, di- and tri-alkoxysilanes), diphenyldialkoxysilanes, vinyltrimethoxysilanes, and other silicone-based molecules and mixtures thereof.

**15.** The method of claim **14**, including selecting said UV inhibitors from a group of materials consisting of a benzophenone, a benzotriazole, a hydroxyphenyltriazine, and other UV inhibitor compounds and mixtures thereof.

**16.** The method of claim **15**, including incorporating a UV stabilizer in said protective skin.

**17.** The method of claim **11**, further including cooling said headlamp lens substrate after molding and prior to cleaning to a temperature between 65° C. and room temperature.

**18.** The method of claim **13**, wherein infusing includes dipping said substrate into an infusion tank including an infusion solution bath for a period of time of between 10-60 seconds at a temperature of between 65-90° C. so as to open pores in said substrate to allow superficial infusion of said protective skin into said substrate.

**19.** The method of claim **18**, wherein said scratch resistance agent and said UV inhibitor are infused in (a) a single step or (b) in multiple steps for the purposes of building up the desired thickness of the hard coating.

**20.** The method of claim **18**, including performing a scratch resistance test to selected infused lenses and adjusting concentration of additives in said infusion solution bath as required until desired results are achieved.

\* \* \* \* \*

modifications for nitrogen oxides as precursors to ozone under § 52.21.

\* \* \* \* \*

[FR Doc. 2011-19897 Filed 8-5-11; 8:45 am]

BILLING CODE 6560-50-P

## DEPARTMENT OF TRANSPORTATION

### National Highway Traffic Safety Administration

#### 49 CFR Part 571

[Docket No. NHTSA-2007-28322]

RIN 2127-AL00

### Federal Motor Vehicle Safety Standards; Lamps, Reflective Devices, and Associated Equipment

**AGENCY:** National Highway Traffic Safety Administration (NHTSA), Department of Transportation (DOT).

**ACTION:** Final rule; response to petitions for reconsideration.

**SUMMARY:** On December 4, 2007, NHTSA published a final rule that amended the Federal motor vehicle safety standard for lamps, reflective devices, and associated equipment with an effective date of September 1, 2008. In response, the agency received thirteen petitions for reconsideration. The effective date of the final rule was delayed in subsequent notices to December 1, 2012. This document corrects several technical errors in the final rule and completes the agency's response to the issues raised in the submitted petitions for reconsideration.

**DATES:** *Effective Date:* The final rule is effective December 1, 2012. The incorporation by reference of certain publications listed in the rule is approved by the Director of the Federal Register as of December 1, 2012.

*Compliance Date:* Voluntary early compliance is permitted beginning August 8, 2011.

*Petitions for Reconsideration:* Petitions for reconsideration of this final rule must be received not later than September 22, 2011.

**ADDRESSES:** Any petitions for reconsideration should refer to the docket number of this document and be submitted to: Administrator, National Highway Traffic Safety Administration, 1200 New Jersey Avenue, SE., West Building, Ground Floor, Docket Room W12-140, Washington, DC 20590.

#### FOR FURTHER INFORMATION CONTACT:

For technical issues: Mr. Mark Price, Office of Crash Avoidance Standards (NVS-121), NHTSA, 1200 New Jersey Avenue, SE., West Building,

Washington, DC 20590 (Telephone: (202) 366-0098) (Fax: (202) 366-7002).

For legal issues: Mr. Thomas Healy, Office of the Chief Counsel (NCC-112), NHTSA, 1200 New Jersey Avenue, SE., West Building, Washington, DC 20590 (Telephone: (202) 366-2992) (Fax: (202) 366-3820).

#### SUPPLEMENTARY INFORMATION:

##### Table of Contents

- I. Executive Summary
- II. Background
- III. Petitions for Reconsideration
  - A. Definitions
  - B. Technical Amendments
  - C. Claims of Substantive Amendment
  - D. Amendments To Improve Clarity
- IV. Agency Analysis and Response
  - A. Definitions
  - B. Technical Amendments
  - C. Claims of Substantive Amendment
  - D. Amendments To Improve Clarity
  - E. Preemptive Effect of FMVSS No. 108
- V. Rulemaking Analyses and Notices

#### I. Executive Summary

On December 4, 2007 NHTSA published a final rule<sup>1</sup> that amended Federal Motor Vehicle Safety Standard (FMVSS) No. 108, *Lamps, reflective devices, and associated equipment*. That final rule reorganized the regulatory text and explicitly added to the text existing requirements from third-party standards that had previously been incorporated by reference. In rewriting the standard NHTSA sought not to make any substantive changes or impose new requirements on regulated parties. The objectives of the rewrite were to: (1) Make requirements easier to find and comprehend; (2) present performance requirements and test procedures together in one place, instead of obliging the user to locate the relevant provisions of third-party documents previously incorporated by reference; and (3) update FMVSS No. 108 to reflect significant letters of interpretation. The rewrite of FMVSS No. 108 was considered administrative in nature because the standard's existing requirements and obligations were not increased, decreased, or substantively modified.

The agency received several petitions for reconsideration which stated some aspects of the final rule failed to adhere to the agency's stated goal of not substantively modifying the standard's existing requirements. Also, the agency received petitions for reconsideration that identified formatting and grammatical errors. In addition to the petitions addressing the technical aspects of the standard, the agency also received a submission questioning the

discussion of the preemptive effect of FMVSS No. 108 included in the preamble of the final rule. After careful review and consideration of the petitions for reconsideration, the agency is amending FMVSS No. 108 in order to correct technical errors within the final rule and is providing a partial response to petitions for reconsideration including the submission addressing the preemptive effect of the rule. The remaining items in the petitions for reconsideration, which include substantive issues and are not addressed within this partial response, will be addressed in a separate notice. We expect to publish that notice before the final rule effective date of December 1, 2012.

#### II. Background

NHTSA published a Notice of Proposed Rulemaking (NPRM) on December 30, 2005<sup>2</sup> proposing to reorganize FMVSS No. 108 and improve the clarity of the standard's requirements, thereby increasing its utility for regulated parties. The proposed administrative rewrite attempted to make the standard more understandable by adopting a simplified numbering scheme to improve organization; by grouping related materials in a more logical and consistent sequence; and by reducing the certification burden of regulated parties who previously needed to review a few dozen third-party documents.

From a regulatory perspective, it was the agency's intention, as expressed in the NPRM, that the administrative rewrite of FMVSS No. 108 would neither result in any current obligations being diminished, nor any new obligations being imposed. In other words, the substantive requirements of the standard would be identical to those of the currently-applicable version of FMVSS No. 108 and underlying documents incorporated by reference. Therefore, we stated that regulated parties would not need to make any changes to their respective products or production processes if our proposal were made final.

The agency considered comments received on the NPRM and published a final rule on December 4, 2007. The final rule incorporated some of the comments received in response to the NPRM by further consolidating test procedures and performance requirements from multiple tables to single paragraphs, incorporating additional Society of Automotive Engineers (SAE) documents directly

<sup>1</sup> 72 FR 68234, (Dec. 4, 2007).

<sup>2</sup> 70 FR 77454, (Dec. 30, 2005).

into the regulatory text, and further consolidating marking requirements. The final rule also added additional tables and figures and changed the structure of the standard to present the requirements in a more standardized and user-friendly manner. The final rule amended FMVSS No. 108 by: (1) Reorganizing the regulatory text so that it provides a more straightforward and logical presentation of the applicable regulatory requirements; (2) incorporating important agency interpretations of the existing requirements; and (3) reducing reliance on third-party documents incorporated by reference. The preamble of the final rule again stated that it was not the agency's intention to create any substantive changes to the standard through the administrative rewrite.

### III. Petitions for Reconsideration

NHTSA received thirteen timely petitions for reconsideration from automotive manufacturers, lighting suppliers, motorcycle manufacturers, material manufacturers, a testing laboratory, and a trial bar association.<sup>3</sup> The Alliance of Automobile Manufacturers (AAM), Ford Motor Company (Ford), Nissan North America (Nissan), Toyota Motor North America (Toyota), Koito Manufacturing Co. LTD (Koito), Valeo Lighting Systems (Valeo), Grote Industries LLC (Grote), Harley-Davidson Motor Company (Harley-Davidson), GE Consumer & Industrial—Lighting (GE), SABIC Innovative Plastics (SABIC), Calcoast, and American Association for Justice (AAJ) submitted petitions for reconsideration of the final rule. The Motor and Equipment Manufacturers Association (MEMA), the Transportation Safety Equipment Institute (TSEI), and the Motor Vehicle Lighting Council (MVLIC), collectively the Associations, submitted a joint petition for reconsideration. Several of the petitions claimed that the final rule imposed new substantive requirements that were not previously included in the old standard. Many of the petitions pointed out grammatical and formatting issues contained in the final rule. The petitions also requested that the agency make additional technical changes and amend the format of some areas of the final rule to further advance the goals of the rewrite. Other petitions claimed that the final rule failed to accurately transpose previously referenced documents or interpretation letters into the regulation text. The petition

submitted by AAJ challenged the preemptive language of the final rule preamble. The remaining petitions requested substantive changes to the rule.

The matters raised in the petitions fall generally into four categories and will be answered as follows: (1) Requests that additional definitions be added to the final rule; (2) requests for technical amendments to the final rule to correct grammar, formatting, and technical issues; (3) claims that the agency added new substantive requirements to the standard during the rewrite; and (4) requests for amendments to the standard to improve readability or clarify certain language. The petitions requesting substantive amendments to the rule will be addressed in another notice.

#### A. Definitions

Several petitioners requested that the agency add new definitions to clarify terms used in the text of the final rule. AAM and Nissan requested that the definition of a clearance lamp be modified to remove the language containing the mounting and spacing requirements for the lamp. AAM and Nissan claimed that the mounting and spacing requirements are contained elsewhere in FMVSS No. 108, therefore, it was not necessary that these requirements be included in the definition. Nissan claimed that removing the mounting and spacing requirements would make the definition more consistent with the definitions of other lamps regulated by the standard. Similarly, both petitioners requested that language regarding mounting and spacing requirements be removed from the definitions of identification and side marker lamps. AAM and Nissan suggested a definition that would eliminate the mounting location description and spacing requirements from each of these three lamp definitions.

The Associations, Grote, and Valeo suggested creating a definition for the term "headlamp system." Each of these petitioners suggested the following definition: "A vehicle-based headlighting system which is composed of headlamps mounted on opposite sides of and symmetrical to the centerline of the vehicle."

Nissan suggested a definition for the term "multiple compartment lamp." Nissan suggested the following definition: "Multiple compartment lamp means a device which gives its indication by two or more areas, illuminated by separate light sources, which are joined by one or more common parts, such as a housing or lens." Nissan pointed out that this

definition was similar to the definition used in an interpretation letter to Al Cunningham on November 3, 1988<sup>4</sup> that responded to his request for clarification as to the meaning of the term "multiple compartment lamp."

The Associations pointed out that the agency placed the definitions for all of the various headlamp types, except "combination headlamp," in the definition section of the final rule. They suggested the following definition be added to the definitions section: "Combination headlamp system: For a two lamp system, a combination of two different headlamps chosen from: Type F, an integral beam headlamp, or a replaceable bulb headlamp and for a four lamp system, any combination of four different headlamps chosen from: Type F, an integral beam headlamp, or a replaceable bulb headlamp." The Associations and Grote recommended replacing the terms "lamps section" or "compartments" with a universal term "lighted sections."

#### B. Technical Amendments

The petitions requested various technical amendments to the standard to amend formatting and grammatical issues. Nissan stated that the agency referenced an American Society for Testing and Materials (ASTM) specification in the final rule in paragraph S14.5.3.2 yet this specification was not listed in paragraph S5.

Nissan pointed out a grammatical error in paragraph S6.4.4. Nissan suggested changing the phrase " \* \* \* overall width, that are \* \* \* " to " \* \* \* overall width, that is \* \* \* "

AAM requested that the "DOT marking" requirement for headlamps located in paragraph S6.5.1 be moved to paragraph S6.5.3 so that it would be located with the other headlamp markings.

The Associations and AAM noted that paragraph S6.5.3 occurs twice, once marked *Headlamp markings* and once marked *Trademark*. They requested that the Trademark paragraph numbering change to S6.5.3.1.

AAM requested that the format of "SEALED BEAM," as shown in paragraph S6.5.3.3.1, be standardized with the format as it appears in Table III, which is not fully capitalized. AAM requested that the phrase be modified to "Sealed Beam" in paragraph S6.5.3.3.1.

AAM stated that in paragraph S7.1.1.11, FMVSS No. 108's revised text uses the term "compartments" even though the preamble to that rule stated

<sup>3</sup>NHTSA also received several petitions for reconsideration after the January 18, 2008 deadline specified in the final rule. It is the agency's policy to treat untimely petitions for reconsideration as petitions for rulemaking. See 49 CFR 553.35.

<sup>4</sup> <http://isearch.nhtsa.gov/files/31350.html>.



that this term would be used in the singular form.

AAM recommended adding a qualifying statement “provided that the requirements of S6.1.3.2 are met” to paragraphs S7.1.1.11.1, similar to the statements used in paragraphs S7.1.2.11.1, S7.2.11.1, and S7.3.11.1, in order to clarify the requirements for multiple compartment lamps.

Nissan requested that the phrase “generated by a 1.0 radius around \* \* \*” be changed to “generated by a 1.0 degree radius around \* \* \*” in paragraph S7.1.1.12.4.

AAM recommended a modification to paragraph S7.2.9, which deals with taillamp markings. AAM requested that the agency change the pointing statement in that paragraph to point to the specific subparagraph S6.5.1.2 rather than paragraph S6.5. AAM also requested that a more specific pointer be added for paragraphs S7.3.9, S7.4.9, S7.5.9, S7.6.9, S7.7.9, S7.8.9, S7.9.9, S7.10.9, S7.11.9, and S8.1.9.

AAM requested that S7.7.4 be changed from pointing to Tables I (a–c) that state “No requirement.” to simply state within that text “No Requirement.” AAM pointed out that this is consistent with other areas of the regulatory text such as in paragraphs S7.7.7 and S7.7.8.

The Associations requested that the paragraph numeration be corrected in the subparagraphs of S7.9.14. They stated that the paragraph structure contains S7.9.14.1.1 and S7.9.14.1.2, however, it does not contain a paragraph S7.9.14.1.

Nissan noted a grammatical error in paragraph S14.2.1.5.2. It requested that the wording be modified from “\* \* \* of multiple compartment lamp or \* \* \*” to “\* \* \* of multiple compartment lamps or \* \* \*”.

Toyota requested that paragraph S14.3.1 be modified to use the abbreviation “in.” for the unit inch instead of the abbreviation “in” without a period.

GE and the Associations requested a modification to paragraph S14.6.9.1.1, which they pointed out incorrectly converts 176 degrees Fahrenheit to 60 degrees Celsius. They requested the Celsius number be changed to 80 degrees.

Nissan and AAM stated that within Table I–a, the subtitle *Additional Lamps, Required on All Multipurpose Passenger Vehicles (MPV), Trucks, and Buses, 2032 MM or More in Overall Width* appears twice. AAM and Nissan also requested that the activation criteria text be moved to the *Device Activation* column from the *Mounting Height* column for the lower beam headlamp, which is currently blank. In

addition, Nissan requested that the activation specifications for the upper beam headlamp read: “Steady burning, except may be flashed for signaling purposes.” Nissan also requested that English units of measurement be added to the *Mounting Height* column of Table I–a for the lower and upper beam headlamps. AAM requested that all measurements in Tables I–a, I–b, and I–c be displayed in both English and metric units. AAM requested that a horizontal line be placed above the DRL subtitle. Both Nissan and AAM requested that the mounting location and color information be moved to the appropriate column for reflex reflectors in Table I–a. Nissan asked that the subtitle for additional lamps required for wide vehicles change the word “truck” to “trucks.” AAM and Nissan requested that the turn signal truck tractor exception be moved to a new line.

AAM noted that a billing code is inappropriately located after Table I–c. AAM requested that, within the mounting location column for the upper beam headlamp, a note be added that states: “See additional requirements in S10.14.1, S10.17.1.2, and S10.17.1.3,” to reference additional mounting requirements for motorcycle headlamps. AAM also noted that the same column for the lower beam headlamp points to paragraph S6.1.4.2.1.3, however, this paragraph does not exist. The Associations and AAM requested that the word “between” be added to the turn signal minimum edge to edge distance.

AAM claimed that the term “Motorcycle Headlamp” in Table III should read “Motorcycle Replaceable Bulb Headlamp” so that it agrees with paragraph S10.17.2. AAM also suggested adding the word “Optional” in the markings of the Table III column for *Lamps (Other Than Headlamps), Reflective Devices, and Associated Equipment*. AAM also stated it found an incorrect pointing statement to S6.5.4.3 for the replaceable bulb headlamp in the *Requirement* column of Table III. AAM believed that the pointer should instead point to paragraph S6.5.3.4.1. AAM also pointed out that Table III does not contain the marking requirements for a replaceable lens headlamp called out in paragraph 5.8.11 of the existing FMVSS No. 108. Finally, AAM requested that the phrase “See requirements” be added to the sealed beam headlamp type designation in the *Marking Location* column.

For Table V–a, Nissan requested that the measurements for the required visibility for the backup lamp should be in both metric and English units.

The Associations, Nissan, and AAM pointed out that the alignment of lighting device functions to their corner points is incorrect in Table V–b. AAM requested the elimination of the billing code from the bottom of that table.

Nissan requested that the word “zone” be replaced with the word “group” in footnote 2 in Table VIII. Nissan also requested that the word “group” replace the word “zone” in footnote 4 of Table XII. Nissan made the same request of footnote 2 of Tables XIV and XV. Nissan requested that the agency amend footnote 2 of Table XVI to replace the word “zone” with the word “group.”

AAM requested that the agency amend footnote 6 of Table IX so that the photometric intensity requirements for stop lamps combined with taillamps correspond with SAE J1398 (MAY 1985), *Stop Lamps for Use on Motor Vehicles 2032 mm or More in Overall Width*, incorporated by reference in the currently applicable version of FMVSS No. 108. AAM stated that footnote 6 of Table IX should be changed to “values followed by a slash \* \* \*” (in contrast to the current “Values preceded by a slash”) for the H–5L test point so that the standard required the correct photometric multiplier for wide vehicles.

In Table XV, Nissan noted that the test points columns should be listed as horizontal first and vertical second.

The Associations claimed that the final rule had an error in Figure 8, “Replaceable Light Source Detection Test Setup,” and requested that dimension “A” be replaced with the term “Light Center Length.” The Associations also requested that Figure 14 be changed. They stated that the material specification for the “Disc. arm Brace & Clamp” should appear as “SAE–AA–6061 T6 or equiv,” and the “Coil Spring and Level Clip” should appear as “Spring Steel SAE 1858 –Cadmium Plate.” Also, they stated that in Figure 14, “5.00 Bubble movement” should be replaced by “5.88 Bubble movement” and the screw “Typ. #18” should be “Typ. #10.” Finally, in Figure 14, the Associations suggested that the dimension of “100.33” should instead be “188.33.”

### C. Claims of Substantive Amendment

Several of the petitions claimed that during the rewrite process the agency created new substantive requirements of FMVSS No. 108 when the agency incorporated SAE standards that petitioners claim were not fully incorporated or failed to accurately transpose the requirements of third party standards.

Valeo stated that paragraph S6.1.1.4 “would prohibit daytime running lights (DRLs) in combination with parking lights.” Valeo maintained that the existing regulatory text allowed DRLs to be incorporated with parking lamps and urged the agency to retain the existing provision. Valeo referenced paragraph S5.5.11(a) of the current standard, which states that any pair of lamps other than parking lamps or fog lamps may be wired as DRLs. Valeo claimed that the fact that parking lights cannot be used as DRLs is evident because parking lamps would not meet the photometric requirements of DRLs. Valeo claimed that there is no way to reconcile Table 1 of SAE J222 (DEC 1970), *Parking Lamps*, with the minimum requirement of 500 candela at point Horizontal-Vertical of the beam pattern required in the regulation text. Valeo pointed out that many vehicles currently use front turn signals that are optically combined with parking lamps as DRLs. Valeo requested that the agency clarify the wording of paragraph S6.1.1.4 to disallow a DRL consisting of the parking lamp alone, while allowing a DRL that is optically combined with the parking lamp.

Calcoast requested a modification to paragraph S6.1.3.2 to clarify the performance requirements for multiple lighted section lamps. This paragraph states that “when multiple lamp arrangements or multiple compartment rear turn signal lamps, stop lamps, or taillamps are used, with only a portion of the compartments or lamps installed on a rigid part of the vehicle, that portion must meet at least the photometric requirements for the applicable single compartment lamp.” Calcoast stated that it is concerned that this language could be interpreted as allowing a multiple lighted section lamp that is part of a multiple lamp arrangement, such as a light-emitting diode (LED) lamp, that is mounted on the fixed portion of the vehicle to comply only with the single lighted section rules and not the multiple lighted section rules. Calcoast asserted that this statement implies that when a multiple lamp arrangement is used, there is no need to confirm that the multiple lamp arrangement meets all requirements for multiple compartment lamps. Calcoast suggested that the text state that the lighting system must comply with all the relevant rules no matter what position the moveable parts have been placed in.

Koito requested that paragraph S6.1.3.2 replace the phrase “rigid part of the vehicle” with the term “fixed body panel.” Koito noted that the term “rigid part of the vehicle” was correctly used

in paragraph S6.1.3.1, however, it stated that it appears the term “fixed body panel” reflects the intent of the July 7, 2000 letter of interpretation to Gary King<sup>5</sup> which states “body mounted lamps (rear turn signal, stop, or tail lamps) are the ones that must be designed to comply with FMVSS [No.] 108.”

Harley-Davidson requested that paragraph S6.2.3 be revised to clarify that the headlamp ornamentation prohibition in paragraph S6.2.3.1 does not apply to motorcycles. Harley-Davidson noted that the provision of FMVSS No. 108 prohibiting headlamp ornamentation is contained in paragraph S7.8.5 of the current standard, a paragraph Harley-Davidson claimed does not apply to motorcycles. Harley-Davidson referenced a December 6, 1999 interpretation letter to Piaggio & C.S.p.A.<sup>6</sup> and a September 29, 2000 letter to Carter Engineering<sup>7</sup> to support its view on these issues.

AAM requested that the markings requirements of a sealed beam headlamp remove the term “molded” in paragraph S6.5.3.3.1. AAM argued that the text of the currently applicable version of FMVSS No. 108 did not require the marking to be molded into the lens.

Ford and AAM requested that the hazard warning pilot indicator requirement be deleted from paragraph S6.6.2. They claimed that the current version of FMVSS No. 108 does not require a hazard pilot indicator light. They maintained that although SAE J910 (JAN 1966), *Hazard Warning Signal Switch*, incorporated by reference in the existing standard, recommends a pilot indicator, this provision was not directly incorporated into the currently applicable version of FMVSS No. 108. They argued that their view is supported by the explicit requirement in the existing regulation for a turn signal indicator lamp. They claimed that since a turn signal pilot indicator was specifically identified in the regulatory text of FMVSS No. 108, not all the requirements of the referenced SAE standard were included in FMVSS No. 108. They maintained that the requirement for a hazard warning pilot indicator was one of the excluded requirements.

Both the Associations and Ford requested changes to paragraph S6.6.3, which specifies the orientation of the license plate holder. Ford requested that the paragraph be deleted, claiming that the rear license plate holder is not a

lamp, reflective device, or piece of associated equipment and is not separately listed as an item in the Table I or Table III of the current rule, and therefore, is not regulated by FMVSS No. 108. Harley-Davidson suggested that this requirement does not apply to motorcycles. Harley-Davidson stated that paragraph S6.1.3.3 of the referenced SAE document SAE J587 (OCT 81), *License Plate Illumination Devices*, excludes motorcycles from that provision. Harley-Davidson also stated that the existing incorporation by reference only applied to the lamps, and not to the license plate holder.

The Associations and Ford requested a change to requirements for turn signal photometric multipliers contained in paragraphs S7.1.1.10.1 through S7.1.1.10.4. The Associations asserted that the currently applicable version of FMVSS No. 108 does not make any distinction between reflector-based, and non-reflector-based optics when calculating the turn signal spacing to other lamps. They requested that paragraphs S7.1.1.10.1 through S7.1.1.10.3 be replaced by the paragraph S5.3.1.7 of the current standard, which contains the currently applicable requirements for turn signal photometric multipliers. Ford referenced the preamble to a previous agency NPRM<sup>8</sup> incorporating an SAE standard on turn signals to support its claim that the graduated turn signal intensity requirements for turn signals located near auxiliary lamps in paragraph S7.1.1.10.4 were not included in the text of the currently applicable version of FMVSS No. 108. Ford requested that paragraphs S7.1.1.10.2, S7.1.1.10.3, S7.1.1.10.4 (b), (c), and (d) be deleted.

AAM requested that paragraph S9.3.4, which deals with turn signal pilot indicator size and color, be removed from the standard because AAM believed that the paragraph imposed new substantive requirements that were not contained in the currently applicable version of the standard. Although AAM noted that the initial requirements published on December 16, 1967<sup>9</sup> did require a turn signal indicator, and specified its size and color based on requirements in SAE J588d (JUN 1966), *Turn Signal Lamps*, AAM claimed that a subsequent revision to the standard on October 31, 1970<sup>10</sup> removed the size and color requirements. AAM claimed that the currently applicable version of FMVSS No. 108 only requires that the turn

<sup>5</sup> <http://isearch.nhtsa.gov/files/21605.ztv.html>.

<sup>6</sup> <http://isearch.nhtsa.gov/files/20867.ztv.html>.

<sup>7</sup> <http://isearch.nhtsa.gov/files/21971.ztv.html>.

<sup>8</sup> 53 FR 35097, (Sep. 1, 1988).

<sup>9</sup> 32 FR 18032, (Dec. 16, 1967).

<sup>10</sup> 35 FR 16840, (Oct. 31, 1970).

signal pilot indicator indicate a turn signal outage in accordance with SAE J588d (JUN 1966) and does not specify size and color requirements for the indicator.

Harley-Davidson requested clarification and confirmation that the headlamp aimability requirements of paragraph S10.18 do not apply to motorcycles. Harley-Davidson claimed that paragraph S7.8 of the currently applicable version of the standard did not require aimability for motorcycle headlamps. Harley-Davidson referenced a letter of interpretation to Piaggio & C.S.p.A dated December 6, 1999 and also a letter to Carter Engineering dated September 29, 2000 to support its argument.

The Associations, Koito, and Calcoast requested that the agency amend paragraph S10.18.9.1.5.1, which specifies the distance at which the cutoff parameter must be measured, to allow measurement from distances greater than 10 m. Paragraph S10.18.9.1.5.1 requires that the cut off parameter be measured at a distance of 10 m with a 10 mm diameter photosensor. The Associations recommended deleting the last sentence of paragraph S10.18.9.1.5.1, or stating that 10 m is the minimum distance allowable for measuring the cutoff parameter. Koito recommended allowing a measuring distance of 18.3 m or more for measuring the cutoff parameter. Calcoast requested that the agency permit cutoff measurements at both 10 m and 25 m. All petitioners agreed that the diameter of the photosensor should appropriately correspond to the measuring distance.

Nissan requested that the inward force test specified in paragraph S14.6.12 be excluded for vehicle headlamp aiming device (VHAD) and visually-optically aimable (VOA) lamps. Nissan stated that the text of the currently applicable version of FMVSS No. 108 does not require VHAD and VOA lamps to conform to this test. Nissan also stated that the test requires an aiming plane, typically found only on externally aimed systems. Finally, Nissan claimed that the test itself is intended to assure that an externally aimable headlamp system can withstand the normal force applied to seat the suction cup onto the lens when affixing the mechanical aiming device.

The Associations and Grote petitioned the agency to add language to allow stop and turn signal lamps designed for use on vehicles 2032 mm or more in overall width, that meet the one lighted section photometric values, to be used on narrow vehicles. They claimed that SAE J1395 (APR 1985), *Front and Rear Turn*

*Signals for Use of Motor Vehicles 2032 mm or More in Overall Width*, and SAE J1398 (MAY 1985) expressly allow this. To support this position the Associations cited an August 22, 1990 interpretation letter from the agency to Hella<sup>11</sup> which stated:

Beginning December 1, 1990, Standard No. 108 will specify two different standards for turn signal lamps. If the lamp is intended for use on multipurpose passenger vehicles, trucks, buses, and trailers whose overall width is 80 inches or more, it must be designed to conform to the SAE Standard J1395 \* \* \*, "Turn Signal Lamps for Use on Motor Vehicles 2032 mm or More in Overall Width," [(APR 1985)]. SAE J1395 also provides that these lamps may be used on vehicles less than this width, except for passenger cars. If a motor vehicle is not equipped with a turn signal lamp designed to conform to SAE J1395, it must be equipped with a turn signal lamp designed to conform to SAE standard J588 \* \* \*, "Turn Signal Lamps for Use on Motor Vehicles Less Than 2032 mm in Overall Width," [(NOV 1984)].

Finally, the Associations stated that a denial of this petition will have a significant cost to the market segment.

Harley-Davidson requested that the minimum Effective Luminous Lens Area requirement for multiple compartment motorcycle stop lamps be added to Table IV-a. Harley-Davidson suggested this value should be 2,200 square mm. Harley-Davidson maintained that the current version of FMVSS No. 108 permits multiple compartment lamps or multiple lamps on motorcycles if the effective projected luminous lens area of each compartment is 2,200 square mm. Harley-Davidson states that the agency confirmed this position in a April 21, 1997 letter of interpretation to Stanley Electric.<sup>12</sup>

Nissan asked that the legacy visibility wording be changed for the turn, stop, and tail lamps in Table V-d. Nissan claimed that Table V-d uses different language than the SAE sub-referenced standard for these lamps on both narrow and wide vehicles. AAM requested that footnote 1 and footnote 4 be removed from Table VIII, *Stop Lamp Photometry Requirements*. AAM maintained that both of these footnotes contain requirements not previously included in FMVSS No. 108.

Nissan requested that the agency reconsider its decision not to amend the footnotes to the photometric tables for required signal lamps in response to comments received by the agency on the NPRM. Nissan stated that the footnotes to the photometric tables could be amended to provide greater clarity to the requirements of the standard

without creating any substantive changes.

In Table XIX, the Associations requested that the lower beam zone defined by the corner point 10U, 90U, 90L, 90R be modified to 10U, 90U, 45L, 45R. Valeo suggested modifying Table XIX(a)(b), and (c) by modifying the first row range from 10U to 90U, 90L to 90R to only state 10U to 90U, eliminating the horizontal angles. Both Valeo and the Associations claimed that the horizontal range was not defined in the currently applicable standard.

#### D. Amendments to Improve Clarity

Commenters requested the following changes to clarify certain provisions of the standard and to further improve readability. Nissan requested that paragraph S6.1.3.4.2 be revised to read: "Accessibility. Each high mounted stop lamp must provide access for convenient replacement of the bulb without a tool specifically designed for that purpose." Nissan stated that this wording would incorporate a February 12, 1998 interpretation letter to Ford Motor Company<sup>13</sup> to clarify the meaning of "special tool."

Harley-Davidson requested that the agency clarify that dual motorcycle head lamps may be horizontally-mounted. Harley-Davidson stated that paragraph S6.1.3.5.1.3 of the rewrite seems to prohibit horizontally-mounted dual motorcycle headlamps. Harley-Davidson claimed that paragraph S7.9.6.2(c) of the current standard permits dual horizontal mounting. Harley-Davidson further claimed that paragraph S10.17.1.3.1 of the rewrite of FMVSS No. 108 continues to permit dual horizontally-mounted motorcycle headlamps.

Koito requested that the agency clarify paragraph S7.3.12.1, which deals with the ratio requirements between stop and tail lamp intensities. Koito requested that this paragraph be modified to say: "When a taillamp on a multipurpose passenger vehicle, truck, trailer, or bus of 2,032 mm or more in overall width, is combined with a stop lamp, the luminous intensity of the stop lamps at each identified test point must be \* \* \*" Koito claimed that this will clarify that the ratio requirement is always applied between stop and tail lamp intensities on wide vehicles and that wide vehicles do not have the 560 mm and 410 mm classification used for narrow vehicles.

Nissan recommended adding a subject to the sentence in paragraph S8.2.1.5 so that the text reads: "Application location. Conspicuity systems need not

<sup>11</sup> <http://isearch.nhtsa.gov/aiam/aiam4773.html>.

<sup>12</sup> <http://isearch.nhtsa.gov/files/14307.ztv.html>.

<sup>13</sup> <http://isearch.nhtsa.gov/files/16788.ztv.html>.

be \* \* \*” Nissan stated that this is consistent with the other paragraphs of that section.

Nissan requested that paragraph S10.1.2 be modified to eliminate the duplicate requirements for motorcycle headlamp systems. Nissan recommended modifying that paragraph to read: “Each motorcycle must be equipped with a headlighting system conforming to S10.17.” This modification would eliminate the allowance of a one half headlighting system within paragraph S10.1.2, because that allowance is set forth within paragraph S10.17, thereby removing redundant requirements.

Koito recommended clarifying the requirements for four headlamp systems by modifying paragraph S10.15.1 to read as follows: “A replaceable bulb headlighting system must consist of either two lamps, each containing either one or two replaceable light sources, or four lamps, each containing a single replaceable light source as specified for the application system in Table II–d. A system must provide in total no more than two upper beams and two lower beams and must incorporate not more than two replaceable light sources in each headlamp.” Koito claimed that its recommended text will limit the number of light sources in each headlamp of a four headlamp system. Koito claimed, that as currently worded, the final rule will allow two replaceable light sources in each headlamp of a four headlamp system, which it further claimed is not consistent with the intent of the original requirement.

Toyota and Koito both requested a modification to paragraph S10.15.5 which deals with additional light sources in a replaceable bulb headlighting system. They requested the term “replaceable light sources” be replaced with the term “light sources” in this paragraph. They claimed that this expression should be the same as is used in paragraph S10.14.5 for integral beam headlighting systems. Toyota also recommended including the phrase “and are replaceable” to the end of that paragraph. Toyota also noted that this change was discussed in the preamble to the final rule, but was not properly included in the final rule text.

Nissan requested that paragraph S10.18.9.5, which deals with visual/optical aiming headlamp photometry, be removed. Nissan claimed that this entire paragraph is redundant with paragraphs S10.13.3, S10.14.6, S10.15.6, S10.16.2, and Table II. Nissan stated that the requirements should only be stated once in the standard.

Nissan requested that paragraph S13.3, which deals with replaceable

headlamp lens markings, be relocated within paragraph S6.5. Nissan stated that the DOT marking requirement in that paragraph is redundant with paragraph S6.5.1. Nissan stated the remaining marking requirements of paragraph S13.3 should be added to a new paragraph enumerated as paragraph S6.5.3.6.

The Associations and SABIC requested a modification to paragraph S14.1.2, which deals with plastic optical materials. The Associations requested that the paragraph be modified to state: “Plastic optical materials. All plastic material used for optical parts such as lenses and reflex reflectors on lamps, or reflective devices required or allowed by this standard must conform to the material test requirements of S14.4.2, unless they are conspicuity treatments that are in accordance with S8.2.1 or S8.2.2.” SABIC requested that the paragraph be modified as follows: “Plastic optical material. All plastic materials used for transparent optical parts such as lenses and reflex reflectors on lamps or reflective devices required or allowed by this standard must conform to the material test requirements of S14.4.2.” Both petitioners pointed out the distinction between reflex reflectors and reflectors. The Associations further stated that conspicuity treatments were not part of the standard when this original language was placed in the standard.

Nissan requested a modification to paragraph S14.2.4.3, which specifies bulb requirements for DRL photometry testing. Nissan requested that this paragraph be revised to read: “Bulb requirements of paragraph S14.2.1.6 apply to DRL photometry, except for the need to operate at the rated mean spherical candela.” Nissan claimed that the text of the final rule, which states that bulbs are to be operated at their rated mean spherical candela, creates a conflict with the requirement in paragraph S14.2.4.1, which requires a fixed 12.8V input be applied to the modules or electrical control units during testing. Nissan stated that it may not be possible to achieve a bulb’s mean rated spherical candela at 12.8V.

Koito asked for a clarification of the requirement in paragraph S14.4.2.1.3, which specifies testing for plastic optical materials. Koito noted that test sample thicknesses are stated to be 1.6 mm, 2.3 mm, 3.2 mm, and 6.4 mm. Koito also noted that the color requirement in paragraph S14.4.2.2.4.5 specifies that after completion of the outdoor exposure test, all materials must conform to the standard’s color test in the range of thickness stated by the manufacturer. Koito asked if a

material thickness of 7 mm can be certified if it was once tested in the four thicknesses stated above, and found satisfactory.

Nissan requested that some information contained in the text of the standard be incorporated into a new table. Nissan requested that the tabulated text in paragraph S14.9.3.11.2.3.1, *Operating Limits*, be titled “Table XXI” and relocated with the other tables instead of being located in its current position.

AAM further requested that Table I–a be broken into two tables that separate the requirements of narrow vehicles from those for wide vehicles.

AAM stated that the requirements for DRLs should not be located in Table I–a because the title of the table *Required Lamps and Reflective Devices* may confuse users trying to locate the requirements. AAM stated that Table I–a should contain a pointing statement to allow the user of the standard to locate the requirements for DRLs elsewhere.

Koito requested that the activation specifications for a high mounted stop lamp in Table I–a be changed to “Steady burning. Must only be activated upon application of the service brakes or may be activated by a device designed to retard the motion of the vehicle.” Koito claimed this change is necessary because, in its view, “a high mounted stop lamp is optional on the activation of a device designed to retard the motion of the vehicle.”

AAM requested that the titles of Tables I–a, I–b, and I–c be amended to include the vehicles to which the tables apply. AAM stated that all of the tables having the same title, *Required Lamps and Reflective Devices*, does not improve the clarity of the standard.

The Associations, Grote, and Valeo requested that the maximum allowable photometric intensity in Table XII for backup lamps on vehicles equipped with a single back up lamp be changed from 300 to 300/600. They further requested the addition of a footnote that states; “the value before the slash (300 cd) applies to each lamp in a multiple lamp system; the value after the slash (600 cd) applies to a single lamp system.” The petitioners stated that FMVSS No. 108 requires backup lamps on vehicles equipped with a single backup lamp to be tested at twice the candela requirements. Industry believes this applies to maximum as well as minimum values.

Nissan suggested removing the term “test points” in footnote 1 of Table XIX, to clarify that all points with the specified boundary must meet the photometric requirements listed in the table. Finally, Nissan requested that all

the tables be presented in a complete manner without splitting a table across multiple pages.

#### IV. Agency Analysis and Response

##### A. Definitions

The agency has considered the requests from Nissan and AAM to modify the definition of clearance, identification, and side marker lamps. For each of these lamps, the agency has verified that the definitions were successfully translated from the applicable SAE document referenced in the currently applicable version of the standard. While the agency believes that the modifications requested by Nissan have the potential to further simplify the definitions of these lamps, modifying the definitions may change the meaning of these terms. The agency believes that it would be better to retain sporadic redundancies in the standard than to risk a substantive modification by changing the definitions of these lamps. Further, such a modification would be outside the scope of the administrative rewrite of the standard. Therefore, the agency is denying these requests.

The agency is denying the request by the Associations, Grote, and Valeo to add a definition for the term "headlamp system." Since this definition did not exist in the existing regulation text, nor in the documents incorporated by reference, the agency considers this addition to be a substantive change not within the scope of the administrative rewrite of the standard.

Nissan requested that the agency incorporate a November 3, 1988 interpretation letter to Al Cunningham in order to clarify the definition of a "multiple compartment lamp." The final rule definition of a multiple compartment lamp is a direct carry-over from text in paragraph S4 of the currently applicable version of FMVSS No. 108. In the NPRM, the agency invited input from interested parties regarding additional interpretations that should be considered for inclusion in the final rule, beyond those proposed by the agency. Nissan's petition was not submitted at that time. It is the agency's intention to take caution not to create a substantive change within this technical correction and partial response to petitions for reconsideration, therefore, we are denying this request by Nissan.

The agency is granting the Associations' request to add a definition of a "combination headlamp." They noted that other lamp types regulated within this standard are defined in the definition section, however, a combination headlamp is not defined

except in Table II–b. The Associations suggested adding a definition that uses the system composition column descriptions from Table II–b in order to construct the following definition: "Combination Headlamp System: For a two lamp system, a combination of two different headlamps chosen from: Type F, an integral beam headlamp, or a replaceable bulb headlamp and for a four lamp system, any combination of four different headlamps chosen from: Type F, an integral beam headlamp, or a replaceable bulb headlamp." This description is consistent with the existing text of the standard found in paragraphs S7.6.2, and S7.6.3 of the final rule. In order to maintain consistency within the standard, the agency will define a combination headlamp as opposed to a combination headlamp system. The definition is as follows: "Combination headlamp means a headlamp that is a combination of two different headlamp types chosen from a type F sealed beam headlamp, an integral beam headlamp, or a replaceable bulb headlamp." The currently applicable standard does not include a stated definition for the term "combination headlamp," however, the agency agrees that such a definition—limited to a combination headlamp rather than to such a system—does not impose any substantive change to the standard, and provides a more straightforward presentation of the requirements.

The Association's request to define "combination headlamp" differs from the request in the petitions from Grote and Valeo to create a definition of "headlamp system." The definition proposed by the Associations does not create new wording within the standard, it uses a description already contained in the standard, and places that description into the definition section. The definition of a "combination headlamp" is therefore added within paragraph S4 as requested by the Associations.

The agency is denying Grote and the Associations' request to use the term "lighted sections" when referring to lamp sections or compartments. It has been the agency's intent during the rewrite of FMVSS No. 108 not to change the language of the current standard or incorporated documents so as to avoid making unintended changes to the standard. Adopting the term "lighted sections" in place of "lamp sections" or "compartments" would alter the standard in a manner that is inconsistent with the goals of the rewrite.

##### B. Technical Amendments

The agency has considered and incorporated corrections in response to the requests to remedy typographical errors, or formatting errors found in the final rule. The agency has declined to make several technical corrections that will be discussed in greater detail in this section.

The agency agrees with Nissan that the ASTM C 150–56 specification is missing from paragraph S5. This specification has been added.

The agency has corrected the grammatical error identified by Nissan in paragraph S6.4.4. Paragraph S6.4.4 has been modified to read as published in this final rule.

The agency is denying the request by AAM to move paragraph S6.5.1, which contains the DOT marking requirements for headlamps. While we do note that other headlamp marking requirements are located in paragraphs S6.5.3, priority within organization will be maintained by keeping the three paragraphs, S6.5.1 DOT markings for headlamps, S6.5.1.1 which deals with DOT conspicuity markings, and S6.5.1.2 which describes the general allowance of placing the DOT marking on lamps other than headlamps, together. We believe it would be inappropriate to place the contents of paragraph S6.5.1.1 and paragraph S6.5.1.2 within the paragraphs of S6.5.3, because these paragraphs are not headlamp specific. Therefore, we are maintaining the current paragraph structure.

The paragraph that was mistakenly numbered S6.5.3, *Trademark*, has been corrected to S6.5.3.1, *Trademark*. Paragraph S6.5.3 no longer appears twice.

The agency is granting the AAM request that the format of the text "SEALED BEAM," located in paragraph S6.5.3.3.1, be modified to lowercase letters that match the same text located in Table III. The text for paragraph S6.5.3.3.1 was derived from paragraph 2.1.1 in SAE 1383 APR 1985, *Performance Requirements for Replacement Bulb Motor Vehicle Headlamps*. In the SAE document the text is all lower case, appearing as "sealed beam." The agency agrees that the letter case of the word "sealed beam" should be the same in Table III as in paragraph S6.5.3.3.1, therefore, both instances have been changed to the lowercase presentation "sealed beam." The agency does note that in this particular case, we do not feel the actual presentation of lower case or upper case notation of the words "sealed beam" is vital to the public's use of the standard,

or to the agency's ability to enforce the existence of the marking.

In response to AAM's request to change the plural term "compartments" to the singular term "compartment," the agency has modified paragraph S7.1.1.11. The agency agrees that the singular form of the term is more appropriate. It now states "S7.1.1.11 Multiple compartment lamps and multiple lamps."

Based on AAM's request, paragraph S7.1.1.11.1 has been modified to read: "A multiple compartment lamp or multiple lamps may be used to meet the photometric requirements of a front turn signal lamp *provided the requirements of S6.1.3.2 are met.*" The agency believes the additional reference to paragraph S6.1.3.2 makes the standard more usable.

As Nissan requested, paragraph S7.1.1.12.4 has been corrected to state: "\* \* \* the clearance lamp is located below the horizontal and within an area generated by a 1.0 degree radius around \* \* \*" This modification corrects the missing word "degree."

As AAM requested, the agency has changed the marking requirements for lamps other than headlamps to point to the specific subparagraph within paragraph 6.5. The agency has changed the pointing statement in the following paragraphs to provide the specificity requested by AAM: S7.1.1.9, S7.1.2.9, S7.2.9, S7.3.9, S7.4.9, S7.5.9, S7.6.9, S7.7.9, S7.8.9, S7.9.9, S7.11.9 and S8.1.9. The pointing statement for these paragraphs now points to paragraph S6.5.1.2 instead of paragraph S6.5. The agency has not changed the pointing statement in paragraph S7.10.9, which deals with DRL markings, because more than one subparagraph within S6.5 may apply to DRL markings. We believe these modified references will allow the users of the standard to find the paragraph of interest more efficiently.

As AAM requested, the agency has removed the references to Tables I-a, I-b, and I-c from paragraph S7.7.4 which now reads "No requirement." The agency agrees that this construction is more usable, compared to referencing Tables I-a, I-b, and I-c which all state "No requirement."

The agency has granted the Associations' request that the paragraph numeration be corrected under paragraph S7.9.14. The structure has been corrected to S7.9.14.1 and S7.9.14.2.

The agency has granted Nissan's request to change paragraph S14.2.1.5.2 to read "Luminous intensity measurements of multiple compartment lamps or multiple lamp arrangements are made either by:" in order to

maintain consistent language throughout the sentence.

We have modified Paragraph S14.3.1, as requested by Toyota, in order to correctly abbreviate the unit "inch." The abbreviation now includes a period after the letters in.

We have granted GE and the Associations' request to modify paragraph S14.6.9.1.1 in order to correct a temperature conversion error. Paragraph S14.6.9.1.1 now lists 80° C as the metric equivalent of 176° F.

The agency has revised all tables to place requirements in the correct column, remove extraneous billing codes, correct the format of table headings and subheadings, and correct pointing statements as requested by petitioners.

Nissan requested that the agency add English units of measurement to the *Mounting Height* column for lower and upper beam headlamps in Table I-a. AAM also requested that the agency add English units of measurement to Tables I-a, I-b, and I-c. The agency notes that the mounting height requirements for upper and lower beam head lamps are listed in both metric and English units in the currently applicable version of FMVSS No. 108, therefore, adding the English units of measurement does not create a substantive change to the standard. The agency grants Nissan's request and has added the English units of measurement to the *Mounting Height* column of Table I-a for both upper and lower beam headlamps. The agency is also adding English units of measurement to the *Mounting Height* column of Table I-c for both upper and lower beams. The agency is denying AAM's request to list all measurements in Tables I-a, I-b, and I-c in both English and metric units as the measurements are not listed in this manner in the currently applicable version of FMVSS No. 108. As stated in both the NPRM and the preamble to the final rule, the agency is attempting to refrain from making any substantive change to the requirements of the standard during the rewrite process. The agency believes that in the process of converting measurements from metric to English or vice versa it is possible to create a substantive change to the requirements of the standard.

We decline to adopt AAM's proposal to add the word "Optional" to the *Markings* column of Table III for *Lamps (Other Than Headlamps), Reflective Devices, and Associated Equipment* because paragraph S6.5.1.2 referenced in that table adequately conveys the installation requirement without redundant wording inside the table. This request is therefore denied.

AAM noted that Table III contained an incorrect reference paragraph for the marking requirements for replaceable bulb headlamps. The agency has changed the reference for replaceable bulb headlamp marking requirements to point to paragraph S6.5.3.4.

We decline to incorporate AAM's request to add marking requirements for replacement lens headlamps to Table III because paragraph S5.8.11 of the existing standard contains requirements for instructions and a replacement seal, neither of which the agency considers appropriate to list among the marking requirements in Table III.

The agency is granting Nissan's request to provide the required visibility measurements in both English and metric units for Table V-a. We have also corrected the alignment of lighting device functions to their corner points in Table V-b.

The agency is granting Nissan's request to replace the word "zone" with the word "group" in footnote 2 of Tables VIII, XIV, and XV and footnote 4 of Table XII. Nissan also requested that the agency amend footnote 2 of Table XVI to replace the word "zone" with the word "group." As neither Tables XVI-a, XVI-b, or XVI-c have a footnote 2, the agency is not in a position to grant this request.

AAM requested that the agency amend footnote 6 of Table IX to clarify that the minimum photometric intensity ratio for stop lamps combined with taillamps on wide vehicles for the H-5L test point was 3:1 not 5:1. The agency agrees that the photometric ratio for the H-5L test point for wide vehicles is 3:1. The agency is granting AAM's request by amending footnote 6 of Table IX to read: "Values followed by a slash (/) apply only to lamps installed on multipurpose passenger vehicles, trucks, trailers, and buses of 2032 mm or more in overall width."

The agency has revised Table XV so that the test points are listed as horizontal first and vertical second as requested by Nissan.

The Associations requested that Figure 8 measurement "A" be replaced with the term "Light Center Length." This measurement and label "A" were directly translated from the text of Figure 8 in the currently applicable version of Standard No. 108. In the currently applicable version of Standard No. 108, the label "A" was used, furthermore, this distance is referenced in paragraphs S14.7.1.1.1, S14.7.1.1.2, and S14.7.1.1.3 as distance "A". Therefore, the agency is denying this request in order to avoid a potentially substantive change by introducing a new term into Figure 8.

The Associations also requested changes to Figure 14 that include changing the “Disc. Arm and Brace Clamp” material from SAE-AA-6961 to SAE-AA-6061. The agency agrees that this was listed incorrectly and has modified Figure 14 accordingly. They also requested that the “Coil Spring and Level clip” material be changed to “Spring Steel SAE 1858—Cadmium Plate.” The agency does not agree as “Spring Steel SAE 1050” is called out in the currently applicable version of this standard. Therefore, we are denying this request. Also, the agency has corrected the value of the bubble movement to 5.08 and changed the screw number to “TYP #10” in Figure 14 because these changes are consistent with the currently applicable version of the standard. The dimension of 100.33 was correctly translated from the currently applicable version of the standard so the agency is denying the Associations’ request to amend that value to 188.33.

GE noted several corrections in the sealed beam drawings that were moved into the part 564 docket. Corrections to these drawings will be made, and the docket will be updated.

### C. Claims of Substantive Amendment

Several of the petitioners claimed that the agency made substantive changes to the requirements of the standard during the rewrite process or requested that the agency clarify portions of the text to ensure that the rewrite did not impose any new requirements. The agency has made all efforts not to impose any new burdens on regulated parties or change the requirements of the standard in any way through the rewrite process. It is the agency’s position that the requirements of FMVSS No. 108 have not changed as a result of the rewrite.

In consideration of Valeo’s request to change the wording of paragraph S6.1.1.4 in order to make it clear that a DRL may be optically combined with a parking lamp in the final rule, the agency attempted to translate the text of the currently applicable version of FMVSS No. 108 without creating substantive changes. Paragraph S6.1.1.4 is derived from paragraph S5.5.11(a) of the existing standard.

The final rule split paragraph S5.5.11(a) into various parts without changing the activation requirements of DRLs. Some of the text was included in paragraph S6.1.1.4 of the final rule.

Table I-a contains the remaining translation of the text of the currently applicable version of FMVSS No. 108 which states that the activation should be “Steady burning. Automatically activated as determined by the vehicle

manufacturer and automatically deactivated when the headlamp control is in any on position.”

In order to avoid a substantive change to the requirements of FMVSS No. 108, the agency does not believe it is appropriate to incorporate any additional letters of interpretation at this time regarding the permissibility of optically combining parking lamps or fog lamps with DRLs. The agency, however, does understand that the final rule text may provide less clarity than the existing standard. Therefore, in order to more strictly adhere to the language in the existing standard, we are modifying paragraph S6.1.1.4 to retain the language allowing any pair of lamps except parking lamps or fog lamps to be wired as DRLs at the option of the manufacturer.

This modification does create a limited amount of redundant text contained in both paragraph S6.1.1.4 and Table I-a, however, the agency considers this small level of redundancy manageable and preferable, in this situation, in order to avoid unintended confusion due to a change in the language in the final rule.

The agency has considered Calcoast’s request to modify paragraph S6.1.3.2, to clarify the requirements of multiple lamp arrangements and multiple compartment rear turns signal, stop lamp, and taillamp combinations. Calcoast stated that this paragraph could be interpreted such as to allow a multiple lighted section lamp that is part of a multiple lamp arrangement and mounted on the fixed portion of the vehicle to meet only the single compartment lamp requirements. Calcoast indicated this situation might occur particularly in a lamp utilizing LED’s as the sources. The section of this paragraph under consideration is the phrase “that portion must meet at least the photometric requirements for the applicable single compartment lamp.”

In developing the NPRM, and ultimately the final rule, the agency relied on a July 12, 2000 interpretation letter to Gary King. The interpretation letter, however, does not specify that a multiple compartment lamp need only meet the single compartment requirements in the multiple lamp arrangement described in that interpretation. Accordingly, the agency believes that paragraph S6.1.3.2 of the final rule could be misinterpreted. Therefore, in response to Calcoast’s request, the paragraph has thus been modified to state: “S6.1.3.2 When multiple lamp arrangements for rear turn signal lamps, stop lamps, or taillamps are used, with only a portion of the lamps installed on a *fixed* part of

the vehicle, the lamp or lamps that are installed to the *non-fixed* part of the vehicle will be considered auxiliary lamps.” The agency believes this modified paragraph adheres to the guidance provided in the King interpretation letter and provides less opportunity for misinterpretation. The revised paragraph S6.1.3.2 also includes the request from Koito to replace the term “rigid” with the term “fixed” as the agency agrees the term “fixed” more appropriately describes the situation discussed in the interpretation letter to Mr. King.

The agency agrees with Harley-Davidson’s claim that paragraph S6.2.3.1, which prohibits any styling, ornament or other feature on the front of the headlamp lens when the lamp is activated, does not apply to motorcycles. This paragraph was derived from the existing regulatory text in paragraph S7.8.5, which contains both the prohibition on styling and ornamentation on headlamp lenses and the requirement the headlamps have aiming devices. As Harley-Davidson pointed out, two letters of interpretation, a December 6, 1999 letter to Piaggio & C.S.p.A, and a September 29, 2000 letter to Carter Engineering, confirm that FMVSS No. 108 does not require motorcycle headlamps to have aiming mechanisms. Within the letter to Carter Engineering, NHTSA stated: “The aiming mechanism requirements of Standard No. 108 are imposed by S7.8, and as indicated previously, we do not intend S7.8.2 to apply to motorcycle headlamps. We intend that the paragraphs of S7.9 Motorcycles and their referenced materials cover motorcycle headlamps.” This ornament prohibition was first added to the standard in 1989<sup>14</sup> and at that time was within the same paragraph as aimability requirements. Therefore, we have modified paragraph S6.2.3.1 as follows: “When activated in the steady burning state, headlamps (*excluding headlamps mounted on motorcycles*) must not have any styling ornament or other feature, such as a translucent cover or grill, in front of the lens.”

AAM requested a change to paragraph S6.5.3.3.1 so that the marking requirements for sealed beam headlamps need not be molded into the lens. We believe that AAM is incorrect in its assertion that the current standard does not require that marking be molded into the lens of sealed beam headlamps. The marking requirements from paragraph S6.5.3.3.1 were derived from current FMVSS No. 108 paragraph S7.3.1 which references SAE J1383

<sup>14</sup> 54 FR 20079, (May 9, 1989).

(APR 1985), *Performance Requirements for Motor Vehicle Headlamps*. SAE J1383 (APR 1985) states, in paragraph S5.4.4, "Headlamp lenses shall be marked with a three letter code. The marking shall be molded in the lens \* \* \*" Thus, the requirement that the marking of a sealed beam headlamp be molded into the lens is clearly part of the existing standard. Accordingly, the agency is maintaining the requirements contained in paragraph S6.5.3.3.1 and is denying AAM's request.

Ford and AAM requested that the hazard warning pilot indicator requirements be deleted from paragraph S6.6.2. They stated that the requirement for a hazard warning signal pilot indicator has never been contained in any previous version of FMVSS No. 108. They contended that the presence of paragraph S3.4.7 in the original version of FMVSS No. 108 published in 1967,<sup>15</sup> (paragraph S5.5.6 in the current version of the standard) which contained the requirements for a turn signal pilot indicator, indicates other pilot indicators were not required under the original version of the standard. They asserted that since FMVSS No. 108 specifically references a turn signal pilot indicator in the text of the standard, requirements for other indicators in SAE standards were not intended to be incorporated by reference into FMVSS No. 108.

NHTSA does not agree with AAM's and Ford's argument, a hazard warning signal pilot indicator is required by the current version of FMVSS No. 108 and SAE standards incorporated by reference. Paragraph S5.1.1 of the current standard requires that vehicles shall be equipped with the lamps, reflective devices, and associated equipment specified in Table I and Table III, and that those devices shall be designed to conform to the SAE standards or recommended practices referenced in those tables. Table I lists a vehicle hazard warning signal unit and a vehicle hazard warning signal flasher as required equipment for all vehicles wider than 80 inches, except trailers, and references SAE J910 (JAN 1966), *Hazard Warning Signal Switch*, and SAE J945 (FEB 1966), *Vehicular Hazard Warning Signal Flasher*. Table III lists a vehicle hazard warning signal operating unit and a vehicle hazard warning signal flasher as required equipment for all vehicles narrower than 80 inches, except trailers and motorcycles, and references SAE J910 (JAN 1966) and SAE J945 (FEB 1966). SAE J910 (JAN 1966) states:

Pilot Indicator Lamps—In vehicles equipped with right- and left-hand turn signal pilot indicators, both pilots and/or a separate pilot shall flash simultaneously while the vehicle hazard operating unit is turned on. In vehicles equipped with a single turn signal pilot indicator, a separate vehicular hazard pilot indicator shall flash and the turn signal pilot may flash while the vehicular hazard operating unit is turned on. If a separate vehicular hazard pilot indicator is used, it shall emit a red color and have a minimum area equivalent to a 0.5 in. diameter circle.

Therefore, Tables I and III, in conjunction with paragraph S5.1.1 of the current standard, require that vehicles equipped with hazard warning signal switches be equipped with a hazard warning signal pilot indicator. We do not agree with the assertion by AAM and Ford that the SAE requirements incorporated by reference for hazard warning lamps do not apply because they were not restated directly in the standard, as was the case with turn signal pilot indicators. Therefore, we are denying this request and retaining the language of paragraph S6.6.2 in its entirety.

The Associations, Ford, and Harley-Davidson requested changes to paragraph S6.6.3, which specifies the orientation of the license plate holder. The agency will address the issue of the applicability of license plate holder requirements in a separate notice.

Ford requested the deletion of paragraphs S7.1.1.10.2, S7.1.1.10.3, S7.1.1.10.4(b), S7.1.1.10.4(c), and S7.1.1.10.4(d) which all deal with the measurement of, and requirements for, front turn signal lamp intensity based on the spatial relationship to any auxiliary lower beam or fog lamp. Ford stated that these requirements, which were derived from the existing standard by way of reference to SAE J588 (NOV 1984) and SAE J1395 (APR 1985), were not previously incorporated fully into the standard by reference. Ford stated that the denial of an SAE petition for rulemaking,<sup>16</sup> which stated, "NHTSA reference to SAE standards is not always absolute, in that parts of standards are referenced or exceptions are made to specific requirements in SAE standards where different or more stringent performance is necessary for safety purposes," demonstrates that it is well and widely understood that not all requirements referenced in SAE standards are intended by the agency to be incorporated into the standard. Ford also cited the final rule preamble that incorporated SAE J588 (NOV 1984) and SAE J1395 (NOV 1984) into FMVSS No.

108. Ford quoted that discussion as stating:

An additional difference between the new SAE turn signal specification and the ones currently contained in FMVSS No. 108 concerns intensity. If a turn signal lamp is closer than 4 inches (100 mm) to a lower beam headlamp, it must have 2.5 times the intensity otherwise required. The SAE applies the factor of 2.5 only if the turn signal is closer than 60 mm to the lower beam headlamp. NHTSA proposed retention of the current requirement. The SAE specification applies the photometric multiplier in three steps, from 60 mm to 100 mm.<sup>17</sup>

The final statement in that discussion concluded, "[g]iven the advent and usage of higher intensity headlamps, there appears to be an even greater need than before to preserve the intensity ratio. NHTSA has done so by retaining the existing requirement."

We do not agree with Ford's position. Ford's argument that NHTSA's incorporation of SAE standards is not always absolute is in reference to cases in which FMVSS No. 108 explicitly states requirements that are different than the SAE documents. In cases where NHTSA does not specifically exclude parts of SAE standards, the entire standard is incorporated by reference. In the rulemaking cited by Ford, neither within the preamble of that final rule, nor in the NPRM was there any discussion of exempting, or applying any intensity multipliers other than those appearing in the SAE document for auxiliary lamps. The key argument for the agency not to adopt the multipliers in the 1984 SAE standards deals with higher intensity headlamps and the spatial relationship of turn signals to those lamps and, thus, is inapplicable to intensity multipliers for turn signals located near auxiliary lamps. As stated in the preamble of the final rule, SAE J588 (NOV 1984) and SAE J1395 (APR 1985) contain additional photometric multiplier requirements beyond those required in paragraph S5.3.1.7 for turn signals located near auxiliary lamps.<sup>18</sup> It is the agency's position that the requirements in paragraph S5.3.1.7 work in conjunction with the requirements in SAE J588 (NOV 1984) and SAE J1395 (APR 1985) and do not preempt them. Therefore, the agency has not removed the paragraphs and denies Ford's requests.

The Associations claimed the text of the currently applicable version of FMVSS No. 108 did not distinguish between non-reflector light sources and reflector light sources for the purposes

<sup>15</sup> 32 FR 18037, (Dec. 16, 1967).

<sup>16</sup> 61 FR 14044, (Mar. 29, 1996).

<sup>17</sup> 55 FR 20158, (May 15, 1990).

<sup>18</sup> 72 FR 68243, (Dec. 4, 2007).



of measuring the distance between a turn signal to a headlamp, or auxiliary lamp. They claimed that paragraph S5.3.1.7 in the existing FMVSS No. 108, which states, “on a motor vehicle on which the front turn signal lamp is less than 100 mm from the lighted edge of a lower beam headlamp, as measured from the optical center of the turn signal lamps, the multiplier applied to obtain the required minimum luminous intensities shall be 2.5” supersedes section 5.1.5.4 of SAE J588 (NOV 1984). Therefore, the Associations requested that paragraphs S7.1.1.10.1 through S7.1.1.10.3 of the final rule be replaced with paragraph S5.3.1.7 of the currently applicable version of FMVSS No. 108.

The agency agrees that the distance between a turn signal lamp and a lower beam headlamp should be measured from the optical center as specified in the text of the currently applicable version of FMVSS No. 108. However, the measurements between a turn signal lamp and an auxiliary lamp are incorporated from SAE J588 (NOV 1984), which included different measurement methods for turn signal lamps that incorporate reflector optics and turn signal lamps that primarily use lens optics. Considering this, paragraph S7.1.1.10.4(a) has been changed to state “where the spacing measurement as measured from the optical center of the turn signal lamp, to the lighted edge of a lower beam headlamp is less than 100 mm, the photometric multiplier must be 2.5.” As stated previously, SAE J588 (NOV 1984) contains requirements that are additional to those contained in paragraph S5.3.1.7 of the current standard. Therefore, we refrain from changing the method for measuring the distance between the turn signal and auxiliary lamps for determining the required photometric multiplier.

AAM claimed that the text of the currently applicable version of FMVSS No. 108 does not specify the size and color of turn signal pilot indicators and requested that paragraph S9.3.4 be removed. AAM asserted the two sentences contained within paragraph S5.5.6 of the currently applicable version of FMVSS No. 108 should be considered separately. AAM stated that the first sentence requires a vehicle equipped with a turn signal operating unit to also have an illuminated pilot indicator. Through the second sentence, the paragraph separately requires that the failure of one or more turn signal lamps to operate should be indicated according to the SAE Standard. Therefore, AAM claimed that the SAE standard recommendations for turn signal pilot indicator size and color are not requirements in FMVSS No. 108.

NHTSA finds that paragraph S5.5.6 of the current standard requires that the turn signal pilot indicator comply with all requirements for turn signal pilot indicators specified in SAE J588 (SEP 1970). Paragraph S9.3.4 of the final rule, which states, “[i]f an indicator is located inside the vehicle it must emit a green colored light and have a minimum area equivalent to a  $\frac{3}{16}$  in diameter circle,” was derived from the currently applicable version of the FMVSS No. 108 paragraph S5.5.6, which states that, “[e]ach vehicle equipped with a turn signal operating unit shall also have an illuminated pilot indicator. Failure of one or more turn signal lamps to operate shall be indicated in accordance with SAE J588 (SEP 1970) \* \* \*”. Furthermore, paragraph 4.5.2 of SAE J588 (SEP 1970) states that, “if the illuminated indicator is located inside the vehicle, for example in the instrument cluster, it should emit a green colored light and have a minimum area equivalent to a  $\frac{3}{16}$  in. diameter circle.”

It is the view of the agency that the phrase “[f]ailure of one or more turn signal lamps to operate shall be indicated in accordance with SAE J588 (SEP 1970),” requires that the turn signal pilot indicator comply in all respects with SAE J588 (SEP 1970). SAE J588 (SEP 1970) contains requirements for pilot indicators to indicate that the turn signal system is off, size and color requirements for the indicator, and visibility requirements for the indicator based on driver eye position. An indicator of a size and color other than the indicator required in SAE J588 (SEP 1970) would not indicate failure of a turn signal lamp to operate in accordance with SAE J588 (1970) because the indicator would not meet the requirements laid out in that standard for size and color. It is the agency’s position that this sentence requires the pilot indicator to indicate that the turn signal is out via an indicator of the size and color and at the eye location specified in the standard. Therefore, no substantive change was imposed by the final rule compared with the existing standard. Accordingly, the agency is denying this request from AAM.

Harley-Davidson requested clarification and confirmation that the headlamp aimability requirements of S10.18 do not apply to motorcycles. As discussed in Harley-Davidson’s request to clarify the applicability of the headlamp ornamentation prohibition to motorcycles, two letters of interpretation, a December, 6, 1999 letter to Piaggio & C.S.p.A, and a September 9, 2000 letter to Carter

Engineering, confirm that this standard does not require motorcycle headlamps to have aiming mechanisms. Within the letter to Mr. Carter, NHTSA stated, “The aiming mechanism requirements of Standard No. 108 are imposed by S7.8, and as I indicated previously, we do not intend S7.8.2 to apply to motorcycle headlamps. We intend the paragraphs of S7.9 *Motorcycles* and their referenced materials to cover motorcycle headlamps.” Accordingly, paragraph S10.18 has been modified to state: “Headlamp aimability performance requirements (*except for motorcycles*).” Paragraph S10.2 is modified to state “Reserved.” The agency does note that in paragraph S14.2.5.5, *Headlamp photometry measurements*, the procedure does require that the headlamp be aimed during testing. Therefore, although the performance requirements of paragraph S10.18 do not apply to motorcycles, they must have the ability to meet the applicable photometric requirements using the testing procedure described in paragraph S14.2.5.

The Associations, Koito and Calcoast requested that the agency amend paragraph S10.18.9.1.5.1, which required that the cutoff parameter for headlamps be measured from a distance of 10 m from a photosensor with a 10 mm diameter because these requirements were not contained in the current version of the standard. The agency provided the measurement distance of 10 m from the photosensor having a diameter of 10 mm for measuring the cutoff parameter as guidance in a letter of interpretation to Tilman Spingler on April 6, 2000.<sup>19</sup> In the agency guidance letter to Mr. Spingler, the agency stated that it intended to incorporate the guidance provided in the letter into FMVSS No. 108 during the next rulemaking involving the standard. The NPRM to this final rule stated that the agency intended to incorporate the April 6, 2000 letter to Mr. Spingler into the revised version of FMVSS No. 108.<sup>20</sup> We believe it is important to identify how the agency will conduct compliance testing and we did this in the NPRM and again discussed the issue in the final rule. Therefore, paragraph S10.18.9.1.5 has not been modified and the petitions from the Associations, Koito, and Calcoast are denied. However, we do note that regulated parties are able to test at different distances if they choose, although NHTSA compliance tests will be done at 10 m. We note the petitioners may

<sup>19</sup> <http://isearch.nhtsa.gov/files/21406.ztv.html>.

<sup>20</sup> 70 FR 77457, (Dec. 30, 2005).

submit data to support a change in the specified distance in a separate petition.

Nissan requested that the inward force test specified in paragraph S14.6.12 be excluded for VHAD and VOA lamps. Nissan stated that the text of the currently applicable version of FMVSS No. 108 did not require VHAD and VOA lamps to conform to this test. Further supporting Nissan's claim, the preamble to a final rule<sup>21</sup> published May 9, 1989 stated:

The deletion of inward force and torque deflection is appropriate for headlighting systems which do not use externally applied aimers, since these tests are intended to show resistance to the effects of the weight and application of external aimers \* \* \* NHTSA believes that vehicle manufacturers will be cautious enough to design vehicles to withstand the likelihood of misaim in [the] event [the vehicle is pushed by hand], and, considering the deletion appropriate only for headlamps which do not have aiming pads for external mechanical aimers, has adopted the proposed modification of applicability of inward force and torque deflection tests.

Koito also pointed to the preamble of the May 9, 1989, final rule in arguing that the inward force only applies to headlamps that are capable of being externally aimed.

The agency agrees that the inward force test was only required for headlamps with external aimers in the text of the currently applicable version of FMVSS No. 108, therefore we have made the following modifications to the standard: "S10.13.4.1 Each sealed beam headlamp must be designed to conform to the performance requirements of the corrosion test, vibration test, inward force test (*for lamps which are externally aimed only*), torque deflection test (*for lamps which are externally aimed only*), headlamp connector test, headlamp wattage test, and aiming adjustment tests of S14.6." "S10.14.7.1 Each integral beam headlamp must be designed to conform to the performance requirements of the corrosion test, temperature cycle test, vibration test, inward force test (*for lamps which are externally aimed only*), headlamp connector test, and aiming adjustment tests of S14.6." "S10.15.7.1 Each replaceable bulb headlamp must be designed to conform to the performance requirements of the corrosion test, corrosion-connector test, dust test, temperature cycle test, humidity test, vibration test, inward force test (*for lamps which are externally aimed only*), headlamp connector test, and aiming adjustment tests of S14.6."

The Associations and Grote requested that language be added to the standard to allow the use of turn signal and stop lamps designed for use on vehicles 2032 mm or more in overall width, which meet the one lighted section photometric values, on narrow vehicles other than passenger cars. The Associations noted that SAE J1395 (APR 1985), the standard applicable to turn signal lamps on wide vehicles, states that a lamp built to this standard may also be used on a narrow vehicle. The Associations pointed to an August 22, 1990 agency interpretation letter to Hella,<sup>22</sup> that stated "SAE J1395 also provides that these lamps [turn signal lamps designed for use on vehicles 2032 mm or more in overall width] may be used on vehicles less than this width, except passenger cars," to support its position.

We disagree with the interpretation of FMVSS No. 108 put forward by the Associations and Grote. We stated in the preamble of the final rule that there are no provisions in the existing standard that allow the installation of wide vehicle stop and turn signal lamps on narrow vehicles in lieu of the clearly stated requirements for narrow vehicles in Table III of the existing standard. We consider the requirements for stop lamps and turn signal lamps used on narrow vehicles in the currently applicable version of FMVSS No. 108 to be clearly stated. There is no agency guidance stating that manufacturers of narrow vehicles may choose an alternative other than Table III for requirements for stop and turn signal lamps for use on narrow vehicles. Neither Table III, SAE J588 (NOV 84), or SAE J586 (FEB 84), *Stop Lamps for Use on Motor Vehicles Less than 2032 mm in Overall Width*, state that lighting from wide vehicles can also be used on narrow vehicles. For narrow vehicles, a lamp must meet the requirements for narrow vehicles as specified in Table III of the currently applicable version of the standard. Further, the agency stated in a May 22, 2003 letter of interpretation to Panor Corporation<sup>23</sup> that turn signal and stop lamps designed for use on both narrow and wide vehicles must meet the requirements of SAE standards applicable to both narrow and wide vehicles. The letter to Panor stated that stop lamps to be used on both narrow and wide vehicles must meet both SAE J1398 (MAY 1985) and SAE J586 (MAY 1984) and turn signal lamps to be used on both narrow and wide vehicles must meet both SAE J1395 (APR 1985) and SAE J588 (NOV 1984). It is the agency's

position that the letter to Panor, not the letter to Hella, states the correct interpretation regarding the use of turn signal and stop lamps designed for wide vehicles on narrow vehicles. Considering these factors, the petitions from the Associations and Grote are denied.

Harley-Davidson requested that the agency amend Table IV-a which contains the requirements for projected luminous lens area to allow a projected luminous lens area of 2200 square mm for multiple compartment stop lamps used on motorcycles. Harley-Davidson stated that an effective projected luminous lens area of 2200 square mm for multiple compartment stop lamps is permitted under the currently applicable version of FMVSS No. 108. The agency agrees that FMVSS No. 108 permits an effective projected luminous lens area of 2200 square mm for multiple compartment stop lamps used on motorcycles. Accordingly, the agency has amended Table IV-a to include a projected luminous lens area of 2200 square mm for multiple compartment stop lamps used on motorcycles.

We are denying Nissan's request to modify the legacy visibility wording for turn, stop, and taillamps within Table V-d because the language suggested by Nissan does not fully correspond with the requirements in the SAE standard referenced by the existing standard. For example, the wording suggested by Nissan might allow for a situation in which visibility, as defined by area, may be compromised within a position less than the required 45 degrees while the area requirement is met at 45 degrees. This situation is currently not permitted.

AAM stated that footnotes 1 and 4 of Table VIII, regarding the photometric intensity values between test points and the maximum intensity of taillamps respectively, were not previously incorporated into the current standard. AAM maintained that footnote 1 is not referenced in current version of FMVSS No. 108 or in SAE J585 (AUG 1977), *Tail Lamps (Rear Position Lamps)*, and that footnote 4 was preempted by figures contained in the current version of FMVSS No. 108.

We are denying AAM's request to remove footnote 1 and footnote 4 from Table VIII. As stated in the preamble of the final rule, Footnote 1 was added to Table VIII of the rewrite unchanged from the text of SAE J575 (AUG 1970), *Test for Motor Vehicle Lighting Devices and Components*, which was previously incorporated by reference in FMVSS No. 108.<sup>24</sup> The agency, however, is revising

<sup>21</sup> 54 FR 20067, (May 9, 1989).

<sup>22</sup> <http://isearch.nhtsa.gov/aiam/aiam4773.html>.

<sup>23</sup> <http://isearch.nhtsa.gov/files/00473.ztv.html>.

<sup>24</sup> 72 FR 68261, (Dec. 4, 2007).

footnote 4 such that it matches the text in paragraph S5.1.1.6 of the existing standard so as not to make substantive changes to the standard during the rewrite process.

The agency is denying Nissan's request to amend the footnotes to photometric tables containing the requirements for signal lamps. In incorporating third-party documents into the text of the rewrite of the standard, the agency sought not to make any changes to the requirements contained in the third-party documents. We believe that this goal is best accomplished by directly incorporating the text from the third-party documents with minimal changes. While further changes to the standard may improve clarity, the agency believes that these changes are outside the scope of the rewrite.

In the preamble of the final rule the agency explained its views on the subject of grouped compliance.<sup>25</sup> The footnotes to the photometric tables allow the failure of a test point in the group to be offset if other points in the group exceed their minimum by the required margin. The agency does not believe that the footnotes contradict the requirements in the photometric tables and declines to amend the footnotes for the reasons stated in the preamble of the final rule.

Valeo and the Associations requested that the agency reconsider its decision to specify a 90L to 90R horizontal range defined in the area of 10U to 90U in the first row of Table XIX. The agency is denying the petitioner's request. In the NPRM the agency stated that it planned to incorporate a July 2, 1999 letter of interpretation to Tilman Spingler<sup>26</sup> which specified a horizontal range of 90L to 90R in the 10U to 90U area.<sup>27</sup> In this letter the agency stated that:

Each of the Figures you reference specify a maximum of 125 candela for test points 10U–90U. The Figures do not state where in space from left to right to locate the vertical line, and thus, they do not specify that a line is to be measured. It follows that the only description of a set of test points is that of the entire area from 90L to 90R and 10U to 90U, i.e., an area from the extreme left of the test point grid to the extreme right of the test point grid, with an elevation of from 10U to 90U.

The agency believes that a horizontal zone of 90L to 90R for the 10U to 90U area flows logically from the requirements of Figures 15–1, 15–2, 17–1, 17–2, 28–1, and 28–2 in the current version of FMVSS No. 108. Therefore,

the agency is retaining the horizontal range specified in the final rule.

#### D. Amendments To Improve Clarity

The agency has considered the requests to amend the standard to provide greater clarity or reorganize portions of the standard to improve readability. The agency has made every effort during the rewrite of FMVSS No. 108 to improve usability of the standard. The agency has granted requests to further improve the standard by moving certain language or removing redundant requirements where we felt that the requested changes could be made without substantively altering the requirements of the standard.

We are denying Nissan's request to modify paragraph S6.1.3.4.2 to include language from a February 12, 1998 interpretation letter to Ford Motor Company to clarify the meaning of the phrase "special tools." In response to petitions for reconsideration, we are not adding new interpretation letters beyond those addressed in the NPRM and final rule.

Harley-Davidson requested that the agency clarify that it is permissible to mount dual motorcycle headlamps horizontally. We agree that paragraph S6.1.3.5.1.3 introduces ambiguity to the requirements for when motorcycle headlamps must be mounted vertically. Paragraph S6.1.3.5.1.3 of the rewrite is derived from paragraph S7.9.1(b) of the currently applicable version of FMVSS No. 108. Paragraph S7.9.1(b) states that a motorcycle headlamp system consisting of half of certain automobile headlamp systems must be mounted vertically. The requirement that a motorcycle headlamp system consisting of half an automobile headlamp system be mounted vertically is also contained in paragraph S10.17(a) of the rewrite of FMVSS No. 108. Because the requirements of S6.1.3.5.1.3 are more clearly stated elsewhere in the rewrite, the agency considers paragraph S6.1.3.5.1.3 to be duplicative. Therefore, we are removing paragraph S6.1.3.5.1.3 from the rewrite of FMVSS No. 108.

Koito requested that paragraph S7.3.12.1, which specifies the requirements for the ratio of intensities between a stop lamp and a taillamp, be modified to clarify that SAE J1398 (MAY 1998), applicable to wide vehicles, does not have a 560 mm or 410 mm classification and always applies the ratio requirement when determining the appropriate photometric multiplier. We agree that there was no 560 mm or 410 mm classification for wide vehicles in the text of the currently applicable version of FMVSS No. 108. However, the agency believes that the paragraphs

of S7.3.12 are clear as written in the final rule. Because no class restrictions are placed within paragraph S7.3.12.1, the requirements apply to all vehicles regardless of width. While we do not believe that we need to modify this paragraph, we do note that Koito's stated understanding of the issue is correct.

As Nissan requested, paragraph S8.2.1.5 has been modified to add a subject to the sentence. It now reads: "Application Location. *Conspicuity systems* need not be \* \* \*"

Nissan requested that paragraph S10.1.2 be modified to eliminate the duplicate requirements for motorcycle headlamp systems. Paragraph S10.1.2 states: "Each motorcycle must be equipped with a headlighting system conforming to S10.17 of this standard or one half of any headlighting system of Table II which provides both a full upper beam and a full lower beam." Paragraph S10.17 states: "\* \* \* a motorcycle headlighting system may consist of: (a) one half of any headlighting system of Table II which provides both a full upper beam and full lower beam, and is designed to conform to the \* \* \*" The agency agrees that this language is needlessly redundant, and has modified paragraph S10.1.2 by removing the reference to headlighting systems comprising half of Table II headlighting systems. Paragraph S10.1.2 now states: "Each motorcycle must be equipped with a headlighting system conforming to S10.17 of this standard."

Koito recommended modifying paragraph S10.15.1, dealing with replaceable bulb headlamp systems, which states: "Installation \* \* \* A system must provide in total not more than two upper beams and two lower beams and must incorporate not more than two replaceable light sources in each headlamp." Koito claimed this text will allow for a four lamp system to contain two replaceable bulbs within each of the four lamps which is not the intention of the original requirement.

The agency believes this paragraph clearly and accurately expresses the text of the currently applicable version of FMVSS No. 108. The text of the paragraph is substantially similar to that of paragraph S7.5(a) of the existing standard. NHTSA does not believe that a change to this paragraph is necessary and is denying this request by Koito.

Koito and Toyota both requested a modification to paragraph S10.15.5 which states: "Additional light sources. A replaceable bulb headlamp may incorporate replaceable light sources that are used for purposes other than headlighting." Both Koito and Toyota requested that the second use of the

<sup>25</sup> 72 FR 68282, (Dec. 4, 2007).

<sup>26</sup> <http://isearch.nhtsa.gov/files/19548.ztv.html>.

<sup>27</sup> 70 FR 77457, (Dec. 30, 2005).

word "replaceable" be deleted from this requirement because they believed that the language implied that light sourced used for purposes other than headlighting incorporated into a replaceable bulb headlamp must always be replaceable. The agency believes that the language used in the final rule is consistent with the current standard and clearly describes the requirements of replaceable bulb headlamps that incorporate other light sources. Therefore, the agency is denying this request. Nissan requested that paragraph S10.18.9.5, which contains photometry requirements for visually/optically aimed headlamps, be deleted. Nissan claimed that this paragraph is redundant with paragraphs S10.13.3, S10.14.6, S10.15.6, S10.16.2, and Table II which contain the photometry requirements for all permissible headlamps. Nissan suggested that these requirements should be stated only once in FMVSS No. 108. The agency agrees that the paragraphs are redundant and we believe that a user of this standard could locate the necessary information without this paragraph with the assistance of Table II. However, the redundancy of paragraph S10.18.9.5 may significantly increase the usability of the standard for a particular user interested primarily in finding the requirements of a visually/optically aimed headlamp. Accordingly, we have not modified paragraph S10.18.9.5 and we are denying Nissan's request.

Nissan requested that the agency reorganize paragraph S13.3 containing the marking requirements for replacement lenses. Nissan noted that marking requirements for replacement lenses are already included in paragraph S6.5.1, along with the other headlamp DOT marking requirements. Nissan also requested that the remaining requirements in paragraph S13.3 be moved with a new paragraph number under paragraph S6.5.3.6 in order to consolidate all the requirements in one place. The agency agrees that keeping the marking requirements together is an important factor in meeting the stated goal of making the standard more user-friendly. Therefore, S13.3 has been deleted, and a new paragraph S6.5.3.6 has been added to read as published in this final rule.

The Associations and SABIC requested a modification to paragraph S14.1.2, which contains the testing specifications for all plastic materials used for optical parts on lamps or reflective devices. SABIC requested that the word "transparent" be added before "optical" and the word "reflex" before the word "reflectors" to clarify that the requirements of this paragraph do not

apply to opaque materials used in light components. The Associations also requested that the word "reflex" be added before the word reflector. We note that paragraph S14.1.2 was transposed from paragraph S5.1.2 of the currently-applicable version of FMVSS No. 108 which states: "Plastic materials used for optical parts such as lenses and reflectors shall conform to SAE Recommended Practice J576 JUL 1991, except that:" The agency notes that neither the word "transparent," nor the word "reflex" was in the text of the currently applicable version of FMVSS No. 108. We believe the word "transparent" could be interpreted such that the addition of this word would create a substantive modification to the requirement and that adding the term "reflex" would also stray from our intention to transpose existing language without making changes. Therefore, we are denying this request.

Nissan requested a modification to paragraph S14.2.4.3, dealing with DRL bulb photometric testing requirements. Nissan maintained that the requirements of this paragraph create conflict with paragraph S14.2.4.1. Paragraph S14.2.4.3 contains a pointing statement to paragraph S14.2.1.6 which states that bulbs are to be operated at their rated mean spherical candela during testing of DRL photometry requirements. Paragraph S14.2.4.1 requires that the bulbs be operated at a fixed 12.8 V input during DRL photometry testing. This creates a conflict within the regulatory text because a bulb's mean spherical candela may not be achieved at 12.8V. In order to eliminate this apparent contradiction, Nissan suggested modifying S14.2.4.3 to state "Bulb requirements of S14.2.1.6 apply to DRL photometry, except for the need to operate at the rated mean spherical candela."

The agency agrees that the last statement in paragraph S14.2.1.6 requiring that bulbs be operated at their mean spherical candela during photometry testing does not apply to DRLs because this requirement is excluded by the "unless otherwise specified" clause within SAE J575e (AUG 1970). The requirement that bulbs be operated at their mean spherical candela does not apply to DRLs because of specific voltage callout in paragraph S11 of the currently applicable version of the standard. Accordingly, paragraph S14.2.4.3 has been modified by removing the reference to paragraph S14.2.1.6 and now reads as follows: "S14.2.4.3 Except for a lamp having a sealed-in bulb, a lamp must meet the applicable requirements of this standard when tested with a bulb whose filament

is positioned within  $\pm .010$  in. of the nominal design position specified in SAE J573d, *Lamp bulbs and Sealed Units*, December 1968, (incorporated by reference, see 571.108 S5.2 of this title) or specified by the bulb manufacturer."

Koito requested a clarification of the requirement in S14.4.2.1.3 that specifies testing for plastic optical materials. Koito questioned if a material thickness of 7 mm can be certified if it was once tested in the four thicknesses required by this standard. The agency does not believe it is appropriate to address this interpretive question within this notice. However, we do note that the Koito request will be addressed in the follow-up notice.

Nissan requested that the table under paragraph S14.9.3.11.2.3.1 be given a title and relocated to the table section of the standard and referenced as Table XXI. We are denying this request. The table is part of paragraph S14.9.3.11.2.3.1, *Operating limits*. The agency feels that the requirements specified in the table are most appropriately located with the other requirements applicable to semiautomatic headlamp beam switching device tests.

AAM requested that Table I-a be separated to create two new tables based on overall vehicle width. AAM stated that splitting Table I-a to create separate tables for narrow and wide vehicles would simplify the standard and make it easier to use. The agency is denying AAM's request. We believe that it is appropriate to group the requirements for both wide vehicles and narrow vehicles together based on the commonality of the requirements for both wide and narrow vehicles.

AAM stated that the requirements for DRLs should not be included in Table I-a because DRLs are optional equipment and Table I-a is entitled *Required Lamps and Reflective Devices*. AAM believed that locating the requirements for DRLs in Table I-a detracts from the ease of usability of the standard. We disagree with AAM's argument. The agency believes that Table I-a is the most appropriate location for the requirements for DRLs. Unlike other optional lamps and lighting equipment installed on vehicles, DRLs, when installed, are regulated according to all the categories contained in Table I-a. We believe that final rule clearly indicates that DRLs are optional equipment. Therefore, AAM's request is denied.

Koito requested that the agency amend the device activation requirements for high mounted stop lamps contained in Table I-a. Koito requested that the agency clarify that

activation of the high mounted stop lamp upon application of a device designed to retard the motion of the vehicle is optional. We agree that activation of the high mounted stop lamp is optional upon application of a device designed to retard the motion of the vehicle and have revised Table I-a to note this distinction.

AAM requested that the titles of Tables I-a, I-b, and I-c be changed to include the vehicles to which the tables apply. NHTSA is denying this request. We feel that the subheadings included in the tables clearly indicate the class of vehicles to which the tables apply.

Valeo, Grote, and the Associations requested that the agency modify Table XII to clarify that when a single backup lamp is used on a vehicle the maximum photometric intensity allowed is 600 candela. The agency agrees and has added the 600 candela value to Table XII and a footnote stating: "the value before the slash applies to each lamp in a multiple lamp system; the value after the slash applies to a single lamp system."

Nissan requested that the agency modify footnote 1 in Tables XIX-a, XIX-b, and XIX-c to clarify the photometry requirements for the test areas specified in the tables. The agency agrees and is modifying footnote 1 in each of the three tables to read: these test points are boundaries; intensity values within this boundary must meet the listed photometry requirement.

The agency has attempted to format the tables of FMVSS No. 108 in the most user friendly manner. Where the agency was able to avoid splitting tables across multiple pages, the agency has done so. We believe that for some of the larger tables contained in the standard, modifications necessary to fit the tables on to a signal page, such as shrinking the text in the table, would make the tables more difficult to use.

#### E. Preemptive Effect of FMVSS No. 108

AAJ requested that the agency remove any reference to preemption of state tort law from the preamble of the final rule. AAJ argued that *Geier v. American Honda Motor Co.*<sup>28</sup> is an unusual, fact-driven case and does not provide a basis for the agency to claim that all Federal motor vehicle safety standards preempt state tort law. AAJ maintained that FMVSS No. 108 is a minimum safety standard and, thus, is not intended to preempt state tort law. AAJ claimed that it was premature for the agency to speculate about the preemptive effect of a rule before the existence of an actual legal conflict on the record. AAJ further

argued that any claim of preemption by the agency is subject to the notice and comment provisions of the *Administrative Procedure Act*.<sup>29</sup>

The agency does not consider AAJ's submission to be a petition for reconsideration, as NHTSA's preemption discussion contained in the preamble is not a rule. Accordingly, we are treating this petition as a simple request to disavow the preemption discussion in the final rule preamble.

We provided the general discussion of implied preemption and *Geier* in accordance with the directive of Executive Order 13132, Federalism, for agencies to analyze the federalism implications of their rulemakings. In that discussion, the agency explained that NHTSA's safety standards can preempt state laws in at least two ways: Either expressly, through the express preemption provision of the Vehicle Safety Act, or impliedly, if State requirements create a conflict and thus stand as an obstacle to the accomplishment and execution of a NHTSA safety standard. The agency would like to note that because most FMVSS are minimum standards, a State common law tort cause of action that seeks to impose a higher standard on motor vehicle manufacturers will generally not be preempted. However, if and when such a conflict does exist—for example, when the standard at issue is both a minimum and a maximum standard—the State common law tort cause of action is impliedly preempted. See *Geier v. American Honda Motor Co.*, 529 U.S. 861 (2000).

To this end, the agency has examined the nature (*e.g.*, the language and structure of the regulatory text) and objectives of the final rule, which like many NHTSA rules, prescribes only a minimum safety standard. As such, NHTSA does not intend that this rule preempt state tort law that would effectively impose a higher standard on motor vehicle manufacturers than FMVSS No. 108. Establishment of a higher standard by means of State tort law would not conflict with the minimum standard announced in FMVSS No. 108. Without any conflict, there could not be any implied preemption of a State common law tort cause of action. For the aforementioned reasons, the agency declines to remove the *Geier* language from its discussion of preemption law.

## V. Rulemaking Analyses and Notices

### A. Executive Order 12866, Executive Order 13563, and DOT Regulatory Policies and Procedures

NHTSA has considered the impact of this rulemaking action under Executive Order 12866, Executive Order 13563, and the Department of Transportation's regulatory policies and procedures. This rulemaking document was not reviewed by the Office of Management and Budget under E.O. 12866, "Regulatory Planning and Review." It is not considered to be significant under E.O. 12866 or the Department's regulatory policies and procedures. This final rule merely corrects technical and typographical errors in FMVSS No. 108. Today's rule will not have any measurable effect on costs or benefits since the rule merely reorganizes and clarifies existing requirements.

### B. Privacy Act

Anyone is able to search the electronic form of all comments received into any of our dockets by the name of the individual submitting the comment (or signing the comment, if submitted on behalf of an association, business, labor union, etc.). You may review DOT's complete Privacy Act Statement in the **Federal Register** published on April 11, 2000 (Volume 65, Number 70; Pages 19477-78) or you may visit <http://docketsinfo.dot.gov/>.

### C. Other Rulemaking Analyses and Notices

In the December 2007 final rule, the agency discussed relevant requirements related to the Regulatory Flexibility Act, the National Environmental Policy Act, Executive Order 13132 (Federalism), the Unfunded Mandates Reform Act, Civil Justice Reform, the National Technology Transfer and Advancement Act, the Paperwork Reduction Act, and Executive Order 13045 (Protection of Children from Environmental Health and Safety Risks). Since that final rule was an administrative rewrite of existing requirements and since today's action simply makes technical corrections to that final rule, today's rule does not affect the agency's analyses in those areas.

### List of Subjects in 49 CFR Part 571

Imports, Incorporation by reference, Motor vehicle safety, Motor vehicles, and Tires.

In consideration of the foregoing, NHTSA is amending 49 CFR Part 571 as follows:

<sup>28</sup> 529 U.S. 861 (2000).

<sup>29</sup> 5 U.S.C. 553.

**PART 571—FEDERAL MOTOR VEHICLE SAFETY STANDARDS**

■ 1. The authority citation for Part 571 continues to read as follows:

**Authority:** 49 U.S.C. 322, 30111, 30115, 30117, 30166; delegation of authority at 49 CFR 1.50.

■ 2. Section 571.108 is amended as follows:

- a. By revising entry 17 in S5.2; paragraphs S6.1.1.4; S6.1.3.2; S6.2.3.1; S6.4.4; S6.5.3; S6.5.3.3.1; S6.5.3.6; S7.1.1.9; S7.1.1.10.4(a); S7.1.1.11; S7.1.1.11.1; S7.1.1.12.4; S7.1.2.9; S7.2.9; S7.3.9; S7.4.9; S7.5.9; S7.6.9; S7.7.4; S7.7.9; S7.8.9; S7.9.9; S7.9.14; S7.11.9; S8.1.9; S8.2.1.5; S10.1.2; S10.13.4.1; S10.14.7.1; S10.15.7.1; S10.18; S14.2.1.5.2; S14.2.4.3; S14.3.1; S14.6.9.1.1; Table I-a; Table I-b; Table I-c; Table III; Table IV-a; Table IV-b; Table IV-c; Table V-a; Table V-d; Table VIII; Table IX; Table XII; Table XIV; Table XV; Table XIX-a; Table XIX-b; Table XIX-c;
- b. By adding a definition of “Combination headlamp system” in S4; entry 18 in S5.2; paragraph S6.5.3.1;
- c. By removing paragraph S6.1.3.5.1.3, removing and reserving paragraph S10.2, and removing paragraph S13.3; and
- d. By removing paragraphs S7.9.14.1.1 and S7.9.14.1.2, and adding paragraphs S7.9.14.1 and S7.9.14.2 in their place.

The revisions and additions to § 571.108 read as follows:

**§ 571.108 Standard No. 108; Lamps, reflective devices, and associated equipment.**

\* \* \* \* \*

*S4 Definitions.*

\* \* \* \* \*

*Combination Headlamp* means a headlamp that is a combination of two different headlamp types chosen from a type F sealed beam headlamp, an integral beam headlamp, or a replaceable bulb headlamp.

\* \* \* \* \*

*S5.2 \* \* \**

17. American Society for Testing and Materials (ASTM) C150–56, published 1956, “Standard Specifications for Portland Cement.” ASTM International, 100 Barr Harbor Drive, PO Box C700, Conshohocken, PA 19428–2959.

18. Illuminating Engineering Society of North America (IES) LM 45, approved April 1980, “IES Approved Method for Electrical and Photometric Measurements of General Service Incandescent Filament Lamps.” Illuminating Engineering Society of North America, 345 East 47th St., New York, NY 10017.

\* \* \* \* \*

S6.1.1.4 *Daytime running lamps.* Any pair of lamps on the front of a passenger car, multipurpose passenger vehicle, truck, or bus, whether or not required by this standard, other than parking lamps or fog lamps, may be wired to be automatically activated, as determined by the manufacturer of the vehicle, in a steady burning state as daytime running lamps (DRLs) in accordance with S7.10.5.

\* \* \* \* \*

S6.1.3.2 When multiple lamp arrangements for rear turn signal lamps, stop lamps, or taillamps are used, with only a portion of the lamps installed on a fixed part of the vehicle, the lamp or lamps that are installed to the non-fixed part of the vehicle will be considered auxiliary lamps.

\* \* \* \* \*

S6.2.3.1 When activated in the steady burning state, headlamps (excluding headlamps mounted on motorcycles) must not have any styling ornament or other feature, such as a translucent cover or grill, in front of the lens

\* \* \* \* \*

S6.4.4 *Legacy visibility alternative.* As an alternative to S6.4.3, each passenger car and motorcycle, and each multipurpose passenger vehicle, truck, trailer, and bus that is of less than 2032 mm overall width, that is manufactured on or before September 1, 2011, and each multipurpose passenger vehicle, truck, trailer, and bus that is of 2032 mm or more overall width, that is manufactured on or before September 1, 2014, must have each lamp located so that it meets the visibility requirements specified in Table V-d.

\* \* \* \* \*

*S6.5.3 Headlamp markings.*

S6.5.3.1 *Trademark.* The lens of each original and replacement equipment headlamp, and of each original and replacement equipment beam contributor must be marked with the name and/or trademark registered with the U.S. Patent and Trademark Office of the manufacturer of such headlamp or beam contributor, of its importer, or any manufacturer of a vehicle equipped with such headlamp or beam contributor. Nothing in this standard authorizes the marking of any such name and/or trademark by one who is not the owner, unless the owner has consented to it.

\* \* \* \* \*

S6.5.3.3.1 Each sealed beam headlamp lens must be molded with “sealed beam” and the appropriate designation code as shown in Table II in characters no less than 6.35 mm in size.

\* \* \* \* \*

S6.5.3.6 Each replacement headlamp lens must also be marked with the manufacturer and the part or trade number of the headlamp for which it is intended, and with the name and/or trademark of the lens manufacturer or importer that is registered with the U.S. Patent and Trademark Office. Nothing in this standard authorizes the marking of any such name and/or trademark by one who is not the owner, unless the owner has consented to it.

\* \* \* \* \*

S7.1.1.9 *Markings.* See S6.5.1.2.

\* \* \* \* \*

*S7.1.1.10.4 Spacing based photometric multipliers.*

(a) where the spacing measurement as measured from the optical center of the turn signal lamp, to the lighted edge of a lower beam headlamp is less than 100 mm the photometric multiplier must be 2.5.

\* \* \* \* \*

*S7.1.1.11 Multiple compartment lamps and multiple lamps.*

S7.1.1.11.1 A multiple compartment lamp or multiple lamps may be used to meet the photometric requirements of a front turn signal lamp provided the requirements of S6.1.3.2 are met.

\* \* \* \* \*

S7.1.1.12.4 Where the clearance lamp is combined with the turn signal lamp, and the maximum luminous intensity of the clearance lamp is located below horizontal and within an area generated by a 1.0 degree radius around a test point, the ratio for the test point may be computed using the lowest value of the clearance lamp luminous intensity within the generated area.

\* \* \* \* \*

S7.1.2.9 *Markings.* See S6.5.1.2.

\* \* \* \* \*

S7.2.9 *Markings.* See S6.5.1.2.

\* \* \* \* \*

S7.3.9 *Markings.* See S6.5.1.2.

\* \* \* \* \*

S7.4.9 *Markings.* See S6.5.1.2.

\* \* \* \* \*

S7.5.9 *Markings.* See S6.5.1.2.

\* \* \* \* \*

S7.6.9 *Markings.* See S6.5.1.2.

\* \* \* \* \*

S7.7.4 *Mounting height.* No requirement.

\* \* \* \* \*

S7.7.9 *Markings.* See S6.5.1.2.

\* \* \* \* \*

S7.8.9 *Markings.* See S6.5.1.2.

\* \* \* \* \*

S7.9.9 *Markings.* See S6.5.1.2.

\* \* \* \* \*

*S7.9.14 Physical tests.*

S7.9.14.1 Each high-mounted stop lamp must be designed to conform to

the performance requirements of the vibration test of S14.5, and the color test and plastic optical material test of S14.4.

S7.9.14.2 Each high-mounted stop lamp that is not mounted inside the vehicle must be designed to conform to the performance requirements of the moisture test, dust test, and corrosion test of S14.5.

\* \* \* \* \*

S7.11.9 *Markings.* See. S6.5.1.2.

\* \* \* \* \*

S8.1.9 *Markings.* See. S6.5.1.2.

\* \* \* \* \*

S8.2.1.5 *Application location.* Conspicuity systems need not be installed, as illustrated in Figure 12–2, on discontinuous surfaces such as outside ribs, stake post pickets on platform trailers, and external protruding beams, or to items of equipment such as door hinges and lamp bodies on trailers and body joints, stiffening beads, drip rails, and rolled surfaces on truck tractors.

\* \* \* \* \*

S10.1.2 Each motorcycle must be equipped with a headlighting system conforming to S10.17 of this standard.

S10.2 [Reserved]

\* \* \* \* \*

S10.13.4.1 Each sealed beam headlamp must be designed to conform to the performance requirements of the corrosion test, vibration test, inward force test (for lamps which are externally aimed only), torque deflection test (for lamps which are externally aimed only), headlamp

connector test, headlamp wattage test, and aiming adjustment tests of S14.6.

\* \* \* \* \*

S10.14.7.1 Each integral beam headlamp must be designed to conform to the performance requirements of the corrosion test, temperature cycle test, vibration test, inward force test (for lamps which are externally aimed only), headlamp connector test, and aiming adjustment tests of S14.6.

\* \* \* \* \*

S10.15.7.1 Each replaceable bulb headlamp must be designed to conform to the performance requirements of the corrosion test, corrosion-connector test, dust test, temperature cycle test, humidity test, vibration test, inward force test (for lamps which are externally aimed only), headlamp connector test, and aiming adjustment tests of S14.6.

\* \* \* \* \*

S10.18 *Headlamp aimability performance requirements (except for motorcycles)*

\* \* \* \* \*

S14.2.1.5.2 Luminous intensity measurements of multiple compartment lamps or multiple lamp arrangements are made either by:

(a) Measuring all compartments together, provided that a line from the optical axis of each compartment or lamp to the center of the photometer sensing device does not make an angle more than 0.6° with the H–V axis, or

(b) Measuring each compartment or lamp separately by aligning its optical

axis with the photometer and adding the value at each test point.

\* \* \* \* \*

S14.2.4.3 Except for a lamp having a sealed-in bulb, a lamp must meet the applicable requirements of this standard when tested with a bulb whose filament is positioned within ± .010 in. of the nominal design position specified in SAE J573d, Lamp bulbs and Sealed Units, December 1968, (incorporated by reference, paragraph S5.2 of this section) or specified by the bulb manufacturer.

\* \* \* \* \*

S14.3.1 *Procedure.* The sample device must be tested for photometry using bulbs having each of four out-of-focus filament positions. Where conventional bulbs with two pin bayonet bases are used, tests must be made with the light source 0.060 in. above, below, ahead, and behind the designated position. If prefocused bulbs are used, the limiting positions at which tests are made must be 0.020 in. above, below, ahead, and behind the designated position. The sample device may be reaimed for each of the out-of-focus positions of the light source.

\* \* \* \* \*

S14.6.9.1.1 An unfixtured sample headlamp in its design mounting position is placed in water at a temperature of 176° ± 5° F (80° ± 3° C) for one hour. The headlamp is energized in its highest wattage mode, with the test voltage at 12.8 ± 0.1 V during immersion.

\* \* \* \* \*

TABLE I–a—REQUIRED LAMPS AND REFLECTIVE DEVICES

Lighting device	Number and color	Mounting location	Mounting height	Device activation
<b>All Passenger Cars, Multipurpose Passenger Vehicles (MPV), Trucks, and Buses</b>				
Lower Beam Headlamps.	White, of a headlighting system listed in Table II.	On the front, at the same height, symmetrically about the vertical centerline, as far apart as practicable.	Not less than 22 inches (55.9 cm) nor more than 54 inches (137.2 cm).	The wiring harness or connector assembly of each headlighting system must be designed so that only those light sources intended for meeting lower beam photometrics are energized when the beam selector switch is in the lower beam position, and that only those light sources intended for meeting upper beam photometrics are energized when the beam selector switch is in the upper beam position, except for certain systems listed in Table II. Steady burning, except that may be flashed for signaling purposes.
Upper Beam Headlamps.	White, of a headlighting system listed in Table II.	On the front, at the same height, symmetrically about the vertical centerline, as far apart as practicable.	Not less than 22 inches (55.9 cm) nor more than 54 inches (137.2 cm).	

TABLE I-a—REQUIRED LAMPS AND REFLECTIVE DEVICES—Continued

Lighting device	Number and color	Mounting location	Mounting height	Device activation
Turn Signal Lamps ....	2 Amber .....  2 Amber or red Truck tractor exception, see S6.1.1.3.	At or near the front, at the same height, symmetrically about the vertical centerline, as far apart as practicable.  On the rear, at the same height, symmetrically about the vertical centerline, as far apart as practicable.	Not less than 15 inches, nor more than 83 inches.	Flash when the turn signal flasher is actuated by the turn signal operating unit.
Taillamps .....	2 Red .....	On the rear, at the same height, symmetrically about the vertical centerline, as far apart as practicable.	Not less than 15 inches, nor more than 72 inches.	Steady burning. Must be activated when the headlamps are activated in a steady burning state or the parking lamps on passenger cars and MPVs, trucks, and buses less than 80 inches in overall width are activated.  May be activated when the headlamps are activated at less than full intensity as Daytime Running Lamps (DRL).
Stop Lamps .....	2 Red .....	On the rear, at the same height, symmetrically about the vertical centerline, as far apart as practicable.	Not less than 15 inches, nor more than 72 inches.	Steady burning. Must be activated upon application of the service brakes. When optically combined with a turn signal lamp, the circuit must be such that the stop signal cannot be activated if the turn signal lamp is flashing. May also be activated by a device designed to retard the motion of the vehicle.
Side Marker Lamps ...	2 Amber .....	On each side as far to the front as practicable.	Not less than 15 inches.	Steady burning except may be flashed for signaling purposes. Must be activated when the headlamps are activated in a steady burning state or the parking lamps on passenger cars and MPVs, trucks, and buses less than 80 inches in overall width are activated.
Reflex Reflectors .....	2 Red (not required on truck tractor).	On each side as far to the rear as practicable.	Not less than 15 inches.	Not applicable.
	2 Amber .....	On each side as far to the front as practicable.	Not less than 15 inches, nor more than 60 inches.	
	2 Red (not required on truck tractor)..	On each side as far to the rear as practicable.		
	2 Red .....	On the rear, at the same height, symmetrically about the vertical centerline, as far apart as practicable.  On a truck tractor may be mounted on the back of the cab not less than 4 inches above the height of the rear tires.		
Backup Lamp .....	1 White Additional lamps permitted to meet requirements.	On the rear .....	No requirement .....	Steady burning. Must be activated when the ignition switch is energized and reverse gear is engaged. Must not be energized when the vehicle is in forward motion.
License Plate Lamp ...	1 White Additional lamps permitted to meet requirements.	On the rear to illuminate license plate from top or sides.	No requirement .....	Steady burning. Must be activated when the headlamps are activated in a steady burning state or when the parking lamps on passenger cars and MPVs, trucks, and buses less than 80 inches in overall width are activated.



TABLE I-a—REQUIRED LAMPS AND REFLECTIVE DEVICES—Continued

Lighting device	Number and color	Mounting location	Mounting height	Device activation
<b>Additional Lamps Required on All Passenger Cars, and on Multipurpose Passenger Vehicles (MPV), Trucks, and Buses, Less Than 2032 MM in Overall Width</b>				
Parking lamps .....	2 Amber or white .....	On the front, at the same height, symmetrically about the vertical centerline, as far apart as practicable.	Not less than 15 inches, nor more than 72 inches.	Steady burning. Must be activated when the headlamps are activated in a steady burning state.
<b>Additional Lamp(s) Required on All Passenger Cars, and on Multipurpose Passenger Vehicles (MPV), Trucks, and Buses, Less Than 2032 MM in Overall Width and With a GVWR of 10,000 Lbs or Less</b>				
High mounted stop lamp.	1 Red, or 2 red where exceptions apply. See Section 6.1.1.2.	On the rear including glazing, with the lamp center on the vertical centerline as viewed from the rear.	Not less than 34 inches except for passenger cars. See Section 6.1.4.1.	Steady burning. Must only be activated upon application of the service brakes or may be activated by a device designed to retard the motion of the vehicle.
<b>Additional Lamps and Reflective Devices Required on All Passenger Cars, Multipurpose Passenger Vehicles (MPV), Trucks, and Buses, 30 Feet or Longer</b>				
Intermediate side marker lamps.	2 Amber .....	On each side located at or near the midpoint between the front and rear side marker lamps.	Not less than 15 inches.	Steady burning except may be flashed for signaling purposes. Must be activated when the headlamps are activated in a steady burning state or when the parking lamps on passenger cars and MPVs, trucks, and buses less than 80 inches in overall width are activated.
Intermediate side reflex reflectors.	2 Amber .....	On each side located at or near the midpoint between the front and rear side reflex reflectors.	Not less than 15 inches, nor more than 60 inches.	Not applicable.
<b>Additional Lamps Required on All Multipurpose Passenger Vehicles (MPV), Trucks, and Buses, 2032 MM or More in Overall Width</b>				
Clearance lamps .....	2 Amber .....	On the front to indicate the overall width of the vehicle, or width of cab on truck tractor, at the same height, symmetrically about the vertical centerline. May be located at a location other than the front if necessary to indicate the overall width of the vehicle, or for protection from damage during normal operation of the vehicle.	As near the top as practicable.	Steady burning.

TABLE I-a—REQUIRED LAMPS AND REFLECTIVE DEVICES—Continued

Lighting device	Number and color	Mounting location	Mounting height	Device activation
Identification lamps ....	2 Red ..... (not required on truck tractor).	On the rear to indicate the overall width of the vehicle, at the same height, symmetrically about the vertical centerline. May be located at a location other than the rear if necessary to indicate the overall width of the vehicle, or for protection from damage during normal operation of the vehicle.	As near the top as practicable, except where the rear identification lamps are mounted at the extreme height of the vehicle.. Practicability of locating lamps on the vehicle header is presumed when the header extends at least 25 mm (1 inch) above the rear doors.	Steady burning.
	3 Amber .....	On the front, at the same height, as close as practicable to the vertical centerline, with lamp centers spaced not less than 6 inches or more than 12 inches apart.	As near the top of the vehicle or top of the cab as practicable.	Steady burning.
	3 Red (not required on truck tractor).	On the rear, at the same height, as close as practicable to the vertical centerline, with lamp centers spaced not less than 6 inches or more than 12 inches apart.	As near the top as practicable. Practicability of locating lamps on the vehicle header is presumed when the header extends at least 25 mm (1 inch) above the rear doors.	Steady burning.

**Additional Lamps Required on All School Buses Except Multifunction School Activity Buses**

Signal warning lamps	2 Red plus 2 amber optional.	On the front of the cab as far apart as practicable, but in no case shall the spacing between lamps be less than 40 inches. Amber lamps, when installed, at the same height as and just inboard of the red lamp.	As high as practicable but at least above the windshield.	Flashing alternately between 60 to 120 cycles per minute, with an activation period sufficient to allow the lamp to reach full brightness, when actuated by a manual switch. Amber lamps, when installed, may only be activated by manual or foot operation, and must be automatically deactivated and the red lamps must be automatically activated when the bus entrance door is opened.
	2 Red plus 2 amber optional.	On the rear cab as far apart as practicable, but in no case shall the spacing between lamps be less than 40 inches. Amber lamps, when installed, at the same height as and just inboard of the red lamp.	As high as practicable but at least above the top of any side window opening.	Flashing alternately between 60 to 120 cycles per minute, with an activation period sufficient to allow the lamp to reach full brightness, when actuated by a manual switch. Amber lamps, when installed, may only be activated by manual or foot operation, and must be automatically deactivated and the red lamps must be automatically activated when the bus entrance door is opened.

TABLE I-a—REQUIRED LAMPS AND REFLECTIVE DEVICES—Continued

Lighting device	Number and color	Mounting location	Mounting height	Device activation
<b>Daytime Running Lamps Permitted But Not Required on Passenger Cars, Multipurpose Passenger Vehicles (MPV), Trucks, and Buses</b>				
Daytime running lamp (DRL).	2 identically colored either white, white to yellow, white to selective yellow, selective yellow, or yellow.	On the front, symmetrically disposed about the vertical centerline if not a pair of lamps required by this standard or if not optically combined with a pair of lamps required by this standard.	Not more than 1.067 meters above the road surface if not a pair of lamps required by this standard or if not optically combined with a pair of lamps required by this standard. See S7.10.13(b) for additional height limitation.	Steady burning. Automatically activated as determined by the vehicle manufacturer and automatically deactivated when the headlamp control is in any "on" position. Each DRL optically combined with a turn signal lamp must be automatically deactivated as a DRL when the turn signal lamp or hazard warning lamp is activated, and automatically reactivated as a DRL when the turn signal lamp or hazard warning lamp is deactivated. See S7.10.10.1(c) for additional activation requirements when mounted close to, or combined with, a turn signal lamp.

TABLE I-b—REQUIRED LAMPS AND REFLECTIVE DEVICES

Lighting device	Number and color	Mounting location	Mounting height	Device activation
<b>ALL TRAILERS</b>				
Turn Signal Lamps ....	2 Red or amber .....	On the rear, at the same height, symmetrically about the vertical centerline, as far apart as practicable.	Not less than 15 inches, nor more than 83 inches.	Flash when the turn signal flasher is actuated by the turn signal operating unit.
Taillamps .....	2 Red or 1 red on trailers less than 30 inches wide.	On the rear, at the same height, symmetrically about the vertical centerline, as far apart as practicable. When a single lamp is installed it must be mounted at or near the vertical centerline.	Not less than 15 inches, nor more than 72 inches.	Steady burning.
Stop Lamps .....	2 Red, or 1 red on trailers less than 30 inches wide.	On the rear, at the same height, symmetrically about the vertical centerline, as far apart as practicable. When a single lamp is installed it must be mounted at or near the vertical centerline.	Not less than 15 inches, nor more than 72 inches.	Steady burning. Must be activated upon application of the service brakes. When optically combined with a turn signal lamp, the circuit must be such that the stop signal cannot be activated if the turn signal lamp is flashing. May also be activated by a device designed to retard the motion of the vehicle.
Side Marker Lamps ...	2 Amber .....	On each side as far to the front as practicable exclusive of the trailer tongue.	Not less than 15 inches.	Steady burning except may be flashed for signaling purposes.
	None required on trailers less than 1829 mm [6 ft] in overall length including the trailer tongue.			
	2 Red .....	On each side as far to the rear as practicable.	Not less than 15 inches. Not more than 60 inches on trailers 2032 mm or more in overall width.	

TABLE I-b—REQUIRED LAMPS AND REFLECTIVE DEVICES—Continued

Lighting device	Number and color	Mounting location	Mounting height	Device activation
Reflex Reflectors. A trailer equipped with a conspicuity treatment in conformance with S8.2 of this standard need not be equipped with reflex reflectors if the conspicuity material is placed at the locations of the required reflex reflectors.	2 Amber .....	On each side as far to the front as practicable exclusive of the trailer tongue.	Not less than 15 inches, nor more than 60 inches.	Not applicable.
	None required on trailers less than 1829 mm [6 ft] in overall length including the trailer tongue.			
	2 Red .....	On each side as far to the rear as practicable.		
License Plate Lamp ...	2 Red or 1 red on trailers less than 30 inches wide.	On the rear, at the same height, symmetrically about the vertical centerline, as far apart as practicable. When a single reflector is installed it must be mounted at or near the vertical centerline..	No requirement .....	Steady burning.
	1 White .....	On the rear to illuminate license plate from top or sides.		
Additional lamps permitted to meet requirements.				

**Additional Lamps and Reflective Devices Required on all Trailers 30 Feet or Longer**

Intermediate side marker lamps.	2 Amber .....	On each side located at or near the midpoint between the front and rear side marker lamps.	Not less than 15 inches.	Steady burning except may be flashed for signaling purposes.
Intermediate side reflex reflectors. A trailer equipped with a conspicuity treatment in conformance with S8.2 of this standard need not be equipped with reflex reflectors if the conspicuity material is placed at the locations of the required reflex reflectors.	2 Amber .....	On each side located at or near the midpoint between the front and rear side reflex reflectors.	Not less than 15 inches, nor more than 60 inches.	Not applicable.

**Additional Lamps Required on all Trailers 2032 MM or More in Overall Width**

Clearance lamps .....	2 Amber .....	On the front to indicate the overall width of the vehicle, at the same height, symmetrically about the vertical centerline. May be located at a location other than the front if necessary to indicate the overall width of the vehicle, or for protection from damage during normal operation of the vehicle.	As near the top as practicable.	Steady burning.
	2 Red .....	On the rear to indicate the overall width of the vehicle, at the same height, symmetrically about the vertical centerline. May be located at a location other than the rear if necessary to indicate the overall width of the vehicle, or for protection from damage during normal operation of the vehicle.	As near the top as practicable, except where the rear identification lamps are mounted at the extreme height of the vehicle. Practicability of locating lamps on the vehicle header is presumed when the header extends at least 25 mm (1 inch) above the rear doors.	Steady burning.

TABLE I-b—REQUIRED LAMPS AND REFLECTIVE DEVICES—Continued

Lighting device	Number and color	Mounting location	Mounting height	Device activation
Identification lamps ....	2 Amber to front and red to rear.	On a boat trailer the requirement for front and rear clearance lamps may be met by installation at or near the midpoint on each side of a dual facing lamp so as to indicate the extreme width. May be located at a location other than the front and the rear if necessary to indicate the overall width of the vehicle, or for protection from damage during normal operation of the vehicle.	As near the top as practicable.	Steady burning.
	3 Red .....	On the rear, at the same height, as close as practicable to the vertical centerline, with lamp centers spaced not less than 6 inches or more than 12 inches apart.	As near the top as practicable. Practicability of locating lamps on the vehicle header is presumed when the header extends at least 25 mm (1 inch) above the rear doors.	Steady burning.

TABLE I-c—REQUIRED LAMPS AND REFLECTIVE DEVICES

Lighting device	Number and color	Mounting location	Mounting height	Device activation
<b>All Motorcycles</b>				
Lower Beam Headlamps.	White, of a headlighting system listed in S10.17.	On the front, at the same height, symmetrically about the vertical centerline, as far apart as practicable. See additional requirements in S10.17.1.1, S10.17.1.2, and S10.17.1.3.	Not less than 22 inches (55.9 cm) nor more than 54 inches (137.2 cm).	The wiring harness or connector assembly of each headlighting system must be designed so that only those light sources intended for meeting lower beam photometrics are energized when the beam selector switch is in the lower beam position, and that only those light sources intended for meeting upper beam photometrics are energized when the beam selector switch is in the upper beam position, except for certain systems listed in Table II.
Upper Beam Headlamps.	White, of a headlighting system listed in S10.17.	On the front, at the same height, symmetrically about the vertical centerline, as far apart as practicable. See additional requirements in S10.17.1.1, S10.17.1.2, and S10.17.1.3.	Not less than 22 inches (55.9 cm) nor more than 54 inches (137.2 cm).	Steady burning, except that may be flashed for signaling purposes.
Turn Signal Lamps ....	2 Amber. None required on a motor driven cycle whose speed attainable in 1 mile is 30 mph or less.	At or near the front, at the same height, symmetrically about the vertical centerline, and having a minimum horizontal separation distance (centerline of lamps) of 16 inches. Minimum edge to edge separation distance between a turn signal lamp and headlamp is 4 inches.	Not less than 15 inches, nor more than 83 inches.	The upper beam or the lower beam, but not both, may be wired to modulate from a higher intensity to a lower intensity in accordance with S10.17.5 Flash when the turn signal flasher is actuated by the turn signal operating unit.

TABLE I-C—REQUIRED LAMPS AND REFLECTIVE DEVICES—Continued

Lighting device	Number and color	Mounting location	Mounting height	Device activation
	2 Amber or red. None required on a motor driven cycle whose speed attainable in 1 mile is 30 mph or less.	At or near the rear, at the same height, symmetrically about the vertical centerline, and having a minimum horizontal separation distance (centerline to centerline of lamps) of 9 inches. Minimum edge to edge separation distance between the turn signal lamp and the taillamp or stop lamp is 4 inches, when a single stop and taillamp is installed on the vertical centerline and the turn signal lamps are red.		
Taillamps .....	1 Red .....	On the rear, on the vertical centerline except that if two are used, they must be symmetrically disposed about the vertical centerline.	Not less than 15 inches, nor more than 72 inches.	Steady burning.
Stop Lamps .....	1 Red .....	On the rear, on the vertical centerline except that if two are used, they must be symmetrically disposed about the vertical centerline.	Not less than 15 inches, nor more than 72 inches.	Must be activated when the headlamps are activated in a steady burning state. Steady burning.
Reflex Reflectors .....	2 Amber .....	On each side as far to the front as practicable.	Not less than 15 inches, nor more than 60 inches.	Must be activated upon application of the service brakes. When optically combined with a turn signal lamp, the circuit must be such that the stop signal cannot be activated if the turn signal lamp is flashing. May also be activated by a device designed to retard the motion of the vehicle.
	2 Red .....	On each side as far to the rear as practicable.		
	1 Red .....	On the rear, on the vertical centerline except that, if two are used on the rear, they must be symmetrically disposed about the vertical centerline.		
License Plate Lamp ...	1 White .....	On the rear to illuminate license plate.	No requirement .....	Steady burning. Must be activated when the headlamps are activated in a steady burning state.
	Additional lamps permitted to meet requirements.	.....	.....	

TABLE III—MARKING REQUIREMENTS LOCATION

Lamp, reflective device, or other component	Marking	Marking location	Requirement
HEADLAMPS, BEAM CONTRIBUTORS, OR HEADLAMP REPLACEABLE LENS.	“DOT” .....	Lens .....	S6.5.1
	Optical axis marking .....	See requirement .....	S10.18.5
	Manufacturer name and/or trademark .....	Lens .....	S6.5.3
	Voltage .....	See requirement .....	S6.5.3
	Part number or trade number .....	See requirement .....	S6.5.3
HEADLAMP REPLACEABLE LENS .....	Manufacturer identification .....	Lens .....	S6.5.3
	Headlamp identification.		
REPLACEABLE BULB HEADLAMPS .....	“U” or “L” (4 lamp system) .....	Lens .....	S10.15.4
	Replaceable bulb type .....	Lens .....	S6.5.3.4
SEALED BEAM HEADLAMPS .....	“sealed beam” .....	Lens .....	S6.5.3.3
	Type designation .....	See requirements .....	S6.5.3.3
INTEGRAL BEAM HEADLAMPS .....	“U” or “L” (4 lamp system) .....	Lens .....	S10.14.4
MOTORCYCLE REPLACEABLE BULB HEADLAMPS.	“motorcycle” .....	Lens .....	S10.17.2
VISUALLY/OPTICALLY AIMED HEADLAMPS.	“VOR” or “VOL” or “VO” .....	Lens .....	S10.18.9.6
EXTERNALLY AIMED HEADLAMPS .....	Aim pad location & “H” or “V” .....	Lens .....	S10.18.7.1
VEHICLE HEADLAMP AIMING DEVICES (VHAD).	Aiming scale(s) .....	See requirement .....	S10.18.8
(HEADLAMP) REPLACEABLE LIGHT SOURCES.	“DOT” .....	See requirement .....	S11.1
	Replaceable light source designation .....	See requirement.	
REPLACEABLE LIGHT SOURCE BAL- LASTS.	Manufacturer name and/or trademark .....	See requirement.	
	Manufacturer name or logo .....	See requirement .....	S11.2
	Part number.		
	Light source identification.		
	Rated laboratory life.		
LAMPS (OTHER THAN HEADLAMPS), REFLECTIVE DEVICES, AND ASSO- CIATED EQUIPMENT.	High voltage warning.		
	Output in watts and volts.		
DAYTIME RUNNING LAMPS (DRL) .....	“DOT” .....	See requirement .....	S6.5.1.2
	“DRL” .....	Lens .....	S6.5.2
CONSPICUITY REFLEX REFLECTORS	“DOT-C” .....	Exposed surface .....	S8.2.2.1
	“DOT-C2” or “DOT-C3” or “DOT-C4” ..	Exposed surface .....	S8.2.1.3

TABLE IV—a—EFFECTIVE PROJECTED LUMINOUS LENS AREA REQUIREMENTS

Lighting device	Passenger cars, multipurpose passenger vehi- cles, trucks, trailers, and buses of less than 2032 mm in overall width minimum effective projected luminous lens area (sq mm)			Multipurpose passenger vehi- cles, trucks, trailers, and buses 2032 mm or more in overall width minimum ef- fective pro- jected lumi- nous lens area each lamp (sq mm)	Motorcycles minimum effective projected lu- minous lens area (sq mm)	
	Single com- partment lamp	Multiple compartment lamp or multiple lamps			Multiple compartment lamp or multiple lamps	
		Each compart- ment or lamp	Combined compartments or lamps		Each compart- ment or lamp	Single or com- bined compart- ments or lamps
Front turn signal lamp .....	2200	.....	2200	7500	2200	2258
Rear turn signal lamp .....	5000	2200	5000	7500	2200	2258
Stop lamp .....	5000	2200	5000	7500	2200	<sup>1</sup> 5000

<sup>1</sup> A motor driven cycle whose speed attainable in 1 mile is 30 mph or less may be equipped with a stop lamp whose minimum effective projected luminous lens area is not less than 2258 sq mm.

TABLE IV-b—EFFECTIVE PROJECTED LUMINOUS LENS AREA REQUIREMENTS

Lighting device	Passenger cars, multipurpose passenger vehicles, trucks, and buses of less than 2032 mm in overall width and with a GVWR of 10,000 lbs or less using a single lamp minimum effective projected luminous lens area (sq mm)	Multipurpose passenger vehicles, trucks, and buses of less than 2032 mm in overall width and with a GVWR of 10,000 lbs or less using dual lamps of identical size and shape minimum effective projected luminous lens area each lamp (sq mm)
High-mounted stop lamp .....	2903	1452

TABLE IV-c—EFFECTIVE PROJECTED LUMINOUS LENS AREA REQUIREMENTS

Lighting device	School bus minimum effective projected luminous lens area each lamp (sq mm)
School bus signal lamp .....	12,258

TABLE V-a—VISIBILITY REQUIREMENTS OF INSTALLED LIGHTING DEVICES

Lighting device	Required visibility
Backup lamp .....	Lamps must be mounted so that the optical center of at least one lamp is visible from any eye point elevation from at least 1828 mm (6 ft) to 610 mm (2 ft) above the horizontal plane on which the vehicle is standing; and from any position in the area, rearward of a vertical plane perpendicular to the longitudinal axis of the vehicle, 914 mm (3 ft), to the rear of the vehicle and extending 914 mm (3 ft) beyond each side of the vehicle.
High-mounted stop lamp .....	Signal must be visible to the rear through a horizontal angle from 45° to the left to 45° to the right of the longitudinal axis of the vehicle. (Single lamp or two lamps together where required by S6.1.1.2 of this standard).
School bus signal lamp .....	Signal of front lamps to the front and rear lamps to the rear must be unobstructed within area bounded by 5° up to 10° down and 30° left to 30° right.

\* \* \* \* \*

TABLE V-d—VISIBILITY REQUIREMENTS OF INSTALLED LIGHTING DEVICES (LEGACY VISIBILITY ALTERNATIVE)

Lighting device	Required visibility <sup>1</sup>
Turn signal lamp .....	<p>All passenger cars, multipurpose passenger vehicles, trucks, buses, motorcycles, and trailers of less than 2032 mm overall width.</p> <p>All multipurpose passenger vehicles, trucks, buses, and trailers of 2032 mm or more overall width.</p> <p>Unobstructed minimum effective projected luminous lens area of 1250 sq mm through horizontal angle of H-V to H-45° OB.</p> <p>Unobstructed minimum effective projected luminous lens area of 1300 sq mm through horizontal angle of H-V to H-45° OB. Where more than one lamp or optical area is lighted on each side of the vehicle, only one such area on each side need comply.</p>
Stop lamp	Unobstructed minimum effective projected luminous lens area of 1250 sq mm through horizontal angle of H-45° IB to H-45° OB. Where more than one lamp or optical area is lighted on each side of the vehicle, only one such area on each side need comply.
Taillamp	Unobstructed minimum effective projected luminous lens area of 2 sq in through horizontal angle of H-45° IB to H-45° OB. Where more than one lamp or optical area is lighted on each side of the vehicle, only one such area on each side need comply.

<sup>1</sup> IB indicates an inboard direction (toward the vehicle's longitudinal centerline) and OB indicates an outboard direction.

\* \* \* \* \*



**TABLE VIII: TAILLAMP PHOTOMETRY REQUIREMENTS**

GROUP NUMBER	TEST POINT (degrees)	PHOTOMETRIC INTENSITY <sup>(1)(2)(4)</sup> (cd)									GROUP MINIMUM PHOTOMETRIC INTENSITY <sup>(1)(2)</sup> (cd)				
		Lighted Sections									Lighted Sections				
		1			2			3			1	2	3		
		MINIMUM	MAXIMUM		MINIMUM	MAXIMUM		MINIMUM	MAXIMUM		MINIMUM	MAXIMUM			
1	20L	5U	0.3	18	0.5	20	0.7	25		0.7	25		1.4	2.4	3.5
		5D	0.3	-	0.5	-	0.7	-	-		0.7	-			
	5L	10U	0.4	18	0.7	20	1.0	25		1.0	25				
		10D <sup>(3)</sup>	0.4	-	0.7	-	1.0	-	-		-	-			
2	10L	5U	0.8	18	1.4	20	2.0	25		2.0	25		2.4	4.2	6.0
		H	0.8	18	1.4	20	2.0	25		2.0	25				
		5D	0.8	-	1.4	-	2.0	-	-		2.0	-			
3	V	5U	1.8	18	3.1	20	4.5	25		4.5	25		9.6	16.8	24.0
		5L	2.0	18	3.5	20	5.0	25		5.0	25				
	V	H	2.0	18	3.5	20	5.0	25		5.0	25				
		5R	2.0	18	3.5	20	5.0	25		5.0	25				
	V	5D	1.8	-	3.1	-	4.5	-	-		4.5	-			
		5U	0.8	18	1.4	20	2.0	25		2.0	25				
4	10R	H	0.8	18	1.4	20	2.0	25		2.0	25		2.4	4.2	6.0
		5D	0.8	-	1.4	-	2.0	-	-		2.0	-			
		10U	0.4	18	0.7	20	1.0	25		1.0	25				
5	5R	10D <sup>(3)</sup>	0.4	-	0.7	-	1.0	-	-		1.0	-	1.4	2.4	3.5
		5U	0.3	18	0.5	20	0.7	25		0.7	25				
	20R	5D	0.3	-	0.5	-	0.7	-	-		0.7	-			
		5U	0.3	18	0.5	20	0.7	25		0.7	25				

(1) The photometric intensity values between test points must not be less than the lower specified minimum value of the two closest adjacent test points on a horizontal or vertical line.  
 (2) If the sum of intensity values for all points in the group is not less than the specified total value for the group, the measured intensity value for each individual test point is not required to meet the minimum value.  
 (3) Where taillamps are mounted with their axis of reference less than 750 mm above the road surface, photometry requirements below 5° down may be met at 5° down rather than at the specified required downward angle.  
 (4) A taillamp shall not exceed the maximum intensity at H or above.

TABLE IX: STOP LAMP PHOTOMETRY REQUIREMENTS									
GROUP NUMBER	TEST POINT (degrees)	MINIMUM PHOTOMETRIC INTENSITY RATIO WHERE COMBINED WITH A TAIL LAMP <sup>(5)</sup>	MINIMUM PHOTOMETRIC INTENSITY <sup>(1)(2)</sup> (cd)			GROUP MINIMUM PHOTOMETRIC INTENSITY (cd)			
			Lighted Sections			Lighted Sections			
			1	2	3	1	2	3	
1	20L	5U	3	10	12	15			
		5D	3	10	12	15			
	5L	10U	3	16	19	22	50	60	70
		10D <sup>(4)</sup>	3	16	19	22			
2	10L	5U	3	30	35	40	100	115	135
		H	3	40	47	55			
	V	5D	3	30	35	40	380	445	520
		5U	5	70	82	95			
3	5L		3/5 <sup>(6)</sup>	80	95	110	380	445	520
		V	5	80	95	110			
	5R		5	80	95	110	100	115	135
		V	3	70	82	95			
	4	10R	5U	3	30	35	40	100	115
H			3	40	47	55			
5D		3	30	35	40	50	60	70	
10U	3	16	19	22					
5	5R	10D <sup>(4)</sup>	3	16	19	22	50	60	70
		5U	3	10	12	15			
	20R	5D	3	10	12	15	300	360	420
<b>MAXIMUM PHOTOMETRIC INTENSITY<sup>(3)</sup></b>									

(1) The measured values at each test point must not be less than 60% of the minimum value.  
 (2) The photometric intensity values between test points must not be less than the lower specified minimum value of the two closest adjacent test points on a horizontal or vertical line.  
 (3) The maximum photometric intensity must not occur over any area larger than that generated by a 0.5° radius within a solid angle defined by the test point range

- (4) Where stop lamps are mounted with their axis of reference less than 750 mm above the road surface, photometry requirements below 5° down may be met at 5° down rather than at the specified required downward angle.
- (5) When a taillamp is combined with a stop lamp and the maximum luminous intensity of the taillamp is located below horizontal and within an area generated by a 0.5° radius around a test point (1.0° radius on lamps installed on a vehicle 2032 mm or more in overall width), the ratio for the test point may be computed by using the lowest value of the taillamp luminous intensity within the generated area.
- (6) Values followed by a slash (/) apply only to lamps installed on multipurpose passenger vehicles, trucks, trailers, and buses of 2032 mm or more in overall width.

**TABLE XII: BACKUP LAMP PHOTOMETRY REQUIREMENTS**

GROUP NUMBER	TEST POINT (degrees)	MAXIMUM PHOTOMETRIC INTENSITY (cd) ANY SINGLE LAMP	TWO LAMP SYSTEMS – EACH LAMP		SINGLE LAMP SYSTEM	
			MINIMUM PHOTOMETRIC INTENSITY (cd) <sup>(1)(4)</sup>	GROUP MINIMUM PHOTOMETRIC INTENSITY (cd)	MINIMUM PHOTOMETRIC INTENSITY (cd) <sup>(1)(4)</sup>	GROUP MINIMUM PHOTOMETRIC INTENSITY (cd)
1 <sup>(2)(3)</sup>	5U	300/600 <sup>(5)</sup>	15		30	
	45L	300/600 <sup>(5)</sup>	15	45	30	90
	5D	-	15		30	
2 <sup>(2)(3)</sup>	30L	300/600 <sup>(5)</sup>	25	50	50	100
	5D	-	25		50	
	10L	300/600 <sup>(5)</sup>	10		20	
3	5U	300/600 <sup>(5)</sup>	20		40	
	10U	300/600 <sup>(5)</sup>	15		30	
	5U	300/600 <sup>(5)</sup>	25	100	50	200
	10U	300/600 <sup>(5)</sup>	10		20	
	5U	300/600 <sup>(5)</sup>	20		40	
	10L	300/600 <sup>(5)</sup>	50		100	
4	5D	-	50		100	
	H	300/600 <sup>(5)</sup>	80		160	
	5D	-	80	360	160	720
	H	300/600 <sup>(5)</sup>	50		100	
	5D	-	50		100	
5 <sup>(2)(3)</sup>	30R	300/600 <sup>(5)</sup>	25	50	50	100
	5D	-	25		50	
6 <sup>(2)(3)</sup>	5U	300/600 <sup>(5)</sup>	15		30	
	H	300/600 <sup>(5)</sup>	15	45	30	90
	5D	-	15		30	

(1) The photometric intensity values between test points must not be less than the lower specified minimum value of the two closest adjacent test points on a horizontal or vertical line.

(2) When two lamps of the same or symmetrically opposite design are used, the tested photometric values along the vertical axis and the averages of the tested photometric values for the same horizontal test point left and right of vertical for one lamp must be used to determine compliance with the requirements.

(3) When two lamps of differing designs are used, they must be tested individually, and the tested photometric values added to determine the combined units compliance with twice the stated requirements.

(4) If the sum of intensity values for all points in the group is not less than the specified total value for the group, the measured intensity value for each individual test point is not required to meet the minimum value.

(5) The value before the slash applies to each lamp in a multiple lamp system; the value after the slash applies to a single lamp system.

\*\*\*\*\*

TABLE XIV: PARKING LAMP PHOTOMETRY REQUIREMENTS				
GROUP NUMBER	TEST POINT (degrees)	MINIMUM PHOTOMETRIC INTENSITY <sup>(1)(2)</sup> (cd)	MAXIMUM PHOTOMETRIC INTENSITY (cd)	GROUP MINIMUM PHOTOMETRIC INTENSITY (cd)
1	20L	5U	125	2.4
		5D	250	
	5L	10U	125	
		10D <sup>(3)</sup>	250	
2	10L	5U	125	3.0
		H	125	
	5D	250		
3	V	5U	125	16.8
		5L	125	
	V	H	125	
		5R	125	
	V	5D	250	
		5U	125	
4	10R	5U	125	3.0
		H	125	
	5D	250		
5	5R	10U	125	2.4
		10D <sup>(3)</sup>	250	
	20R	5U	125	
		5D	250	

<sup>(1)</sup> The photometric intensity values between test points must not be less than the lower specified minimum value of the two closest adjacent test points on a horizontal or vertical line.

<sup>(2)</sup> If the sum of intensity values for all points in the group is not less than the specified total value for the group, the measured intensity value for each individual test point is not required to meet the minimum value.

<sup>(3)</sup> Where parking lamps are mounted with their axis of reference less than 750 mm above the road surface, photometry requirements below 5° down may be met at 5° down rather than at the specified required downward angle.

**TABLE XV: HIGH-MOUNTED STOP LAMP PHOTOMETRY REQUIREMENTS**

GROUP NUMBER	TEST POINT (degrees)	MINIMUM PHOTOMETRIC INTENSITY <sup>(1)(2)(3)</sup> (cd)	GROUP MINIMUM PHOTOMETRIC INTENSITY <sup>(3)</sup> (cd)	
1	V	5U	25	
	5L	H	25	
	V	H	25	
	5R	H	25	
	V	5D	25	125
	5R	5U	25	
10R	5U	16	98	
10R	H	16		
10R	5D	16		
5R	5D	25		
5L	5U	25		98
10L	5U	16		
10L	H	16		
10L	5D	16		
5L	5D	25		
10L	10U	8	32	
V	10U	16		
10R	10U	8		
<b>MAXIMUM PHOTOMETRIC INTENSITY<sup>(4)</sup></b>				160

(1) The photometric intensity values between test points must not be less than the lower specified minimum value of the two closest adjacent test points on a horizontal or vertical line.  
 (2) The photometric intensity at each test point must not be less than 60% of the specified minimum value when considering overall group photometry tables.  
 (3) Where a pair of lamps identical in size and shape are used due to vehicle construction, they together must meet photometric requirements.  
 (4) The maximum photometric intensity must not occur over any area larger than that generated by a 0.25° radius within a solid cone angle within the rectangle bounded by test points 10U-10L, 10U-10R, 5D-10L, and 5D-10R.

\*\*\*\*\*

**TABLE XIX-a: HEADLAMP LOWER BEAM PHOTOMETRY REQUIREMENTS**

TEST POINT (degrees)	LOWER BEAM # 1M (LB1M)			LOWER BEAM # 1V (LB1V)			LOWER BEAM # 2M (LB2M)			LOWER BEAM # 2V (LB2V)		
	MAXIMUM PHOTOMETRIC INTENSITY (cd)	MINIMUM PHOTOMETRIC INTENSITY (cd)	MAXIMUM PHOTOMETRIC INTENSITY (cd)	MINIMUM PHOTOMETRIC INTENSITY (cd)	MAXIMUM PHOTOMETRIC INTENSITY (cd)	MINIMUM PHOTOMETRIC INTENSITY (cd)	MAXIMUM PHOTOMETRIC INTENSITY (cd)	MINIMUM PHOTOMETRIC INTENSITY (cd)	MAXIMUM PHOTOMETRIC INTENSITY (cd)	MINIMUM PHOTOMETRIC INTENSITY (cd)	MAXIMUM PHOTOMETRIC INTENSITY (cd)	MINIMUM PHOTOMETRIC INTENSITY (cd)
(1) 10U to 90U	125	-	125	-	125	-	125	-	125	-	125	-
4U	-	64	-	64	-	64	-	64	-	64	-	64
2U	-	135	-	135	-	135	-	135	-	135	-	135
1.5U	-	200	-	200	-	200	-	200	-	200	-	200
1.5U	1,400	-	1,400	-	1,400	-	1,400	-	1,400	-	1,400	-
1U	700	-	700	-	700	-	700	-	700	-	700	-
0.5U	1,000	-	1,000	-	1,000	-	1,000	-	1,000	-	1,000	-
0.5U	2,700	500	2,700	500	2,700	500	2,700	500	2,700	500	2,700	500
H	5,000	-	5,000	-	5,000	-	5,000	-	5,000	-	5,000	-
H	-	135	-	135	-	135	-	135	-	135	-	135
H	-	64	-	64	-	64	-	64	-	64	-	64
0.5D	3,000	-	3,000	-	3,000	-	3,000	-	3,000	-	3,000	-
0.5D	20,000	10,000	20,000	10,000	20,000	10,000	20,000	10,000	20,000	10,000	20,000	10,000
0.6D	-	-	-	10,000	-	10,000	-	10,000	-	10,000	-	10,000
0.86D	-	-	-	4,500	-	4,500	-	4,500	-	4,500	-	4,500
0.86D	-	-	12,000	1,800	-	1,800	-	1,800	-	1,800	-	1,800
1D	-	1,000	-	-	-	1,000	-	1,000	-	1,000	-	1,000
1.5D	-	15,000	-	15,000	-	15,000	-	15,000	-	15,000	-	15,000
1.5D	-	1,000	-	1,000	-	1,000	-	1,000	-	1,000	-	1,000
2D	-	-	-	1,250	-	1,250	-	1,250	-	1,250	-	1,250
2D	-	850	-	1,000	-	1,000	-	850	-	850	-	1,000
2.5D	-	-	-	-	-	-	-	-	-	-	-	-
2.5D	-	-	-	-	-	-	-	-	-	-	-	-
4D	7,000	-	10,000	-	10,000	-	10,000	-	10,000	-	10,000	-
4D	12,500	-	12,500	-	12,500	-	12,500	-	12,500	-	12,500	-
4D	-	-	-	300	-	300	-	-	-	-	-	300

(1) These test points are boundaries, intensity values within this boundary must meet the listed photometry requirement.

**TABLE XIX-b: HEADLAMP LOWER BEAM PHOTOMETRY REQUIREMENTS**

TEST POINT (degrees)	LOWER BEAM #3 M (LB3M)		LOWER BEAM #3V (LB3V)		LOWER BEAM #4M (LB4M)		LOWER BEAM #5M (LB5M)	
	MAXIMUM PHOTOMETRIC INTENSITY (cd)	MINIMUM PHOTOMETRIC INTENSITY (cd)	MAXIMUM PHOTOMETRIC INTENSITY (cd)	MINIMUM PHOTOMETRIC INTENSITY (cd)	MAXIMUM PHOTOMETRIC INTENSITY (cd)	MINIMUM PHOTOMETRIC INTENSITY (cd)	MAXIMUM PHOTOMETRIC INTENSITY (cd)	MINIMUM PHOTOMETRIC INTENSITY (cd)
(1) 10U to 90U	125	-	125	-	125	-	125	-
4U	-	64	-	64	-	64	-	64
2U	-	135	-	135	-	135	-	135
1.5U	-	200	-	200	-	200	-	200
1.5U	1,400	-	1,400	-	1,400	-	1,400	-
1U	700	-	700	-	700	-	700	-
0.5U	1,000	-	1,000	-	1,000	-	1,000	-
0.5U	2,700	500	2,700	500	2,700	500	2,700	500
H	-	-	-	-	-	-	5,000	-
H	-	135	-	135	-	135	-	135
H	-	64	-	64	-	64	-	64
0.5D	2,500	-	-	-	2,500	-	3,000	-
0.5D	20,000	8,000	-	-	20,000	8,000	20,000	10,000
0.6D	-	-	-	10,000	-	-	-	-
0.86D	-	--	-	4,500	-	-	-	-
0.86D	-	-	12,000	1,800	-	-	-	-
1D	-	750	-	-	-	750	-	1,000
1.5D	-	15,000	-	15,000	-	15,000	-	15,000
1.5D	-	750	-	-	-	750	-	1,000
2D	-	-	-	1,250	-	-	-	-
2D	-	700	-	1,000	-	700	-	850
2.5D	-	-	-	-	-	-	-	2,500
2.5D	-	-	-	-	-	-	-	1,000
4D	-	-	-	-	-	-	7,000	-
4D	12,500	-	12,500	-	12,500	-	12,500	-
4D	-	-	-	300	-	-	-	-

(1) These test points are boundaries, intensity values within this boundary must meet the listed photometry requirement.



TABLE XIX-c: HEADLAMP LOWER BEAM PHOTOMETRY REQUIREMENTS		
TEST POINT (degrees)	MAXIMUM PHOTOMETRIC INTENSITY (cd)	LOWER BEAM # 4 V (LB4V) MINIMUM PHOTOMETRIC INTENSITY (cd)
	( <sup>1</sup> ) 10U to 90U	125
4U	-	64
2U	-	135
1.5U	-	200
1.5U	1,400	-
1U	700	-
0.5U	1,000	-
0.5U	2,700	500
H	5,000	-
H	-	135
H	-	64
0.5D	-	-
0.5D	-	-
0.6D	-	10,000
0.86D	-	4,500
0.86D	12,000	1,800
1D	-	-
1.5D	-	15,000
1.5D	--	-
2D	-	1,250
2D	-	1,000
2.5D	-	2,500
2.5D	-	1,000
4D	10,000	-
4D	12,500	-
4D	-	300

(<sup>1</sup>) These test points are boundaries, intensity values within this boundary must meet the listed photometry requirement.

\*  
\*  
\*  
\*  
\*

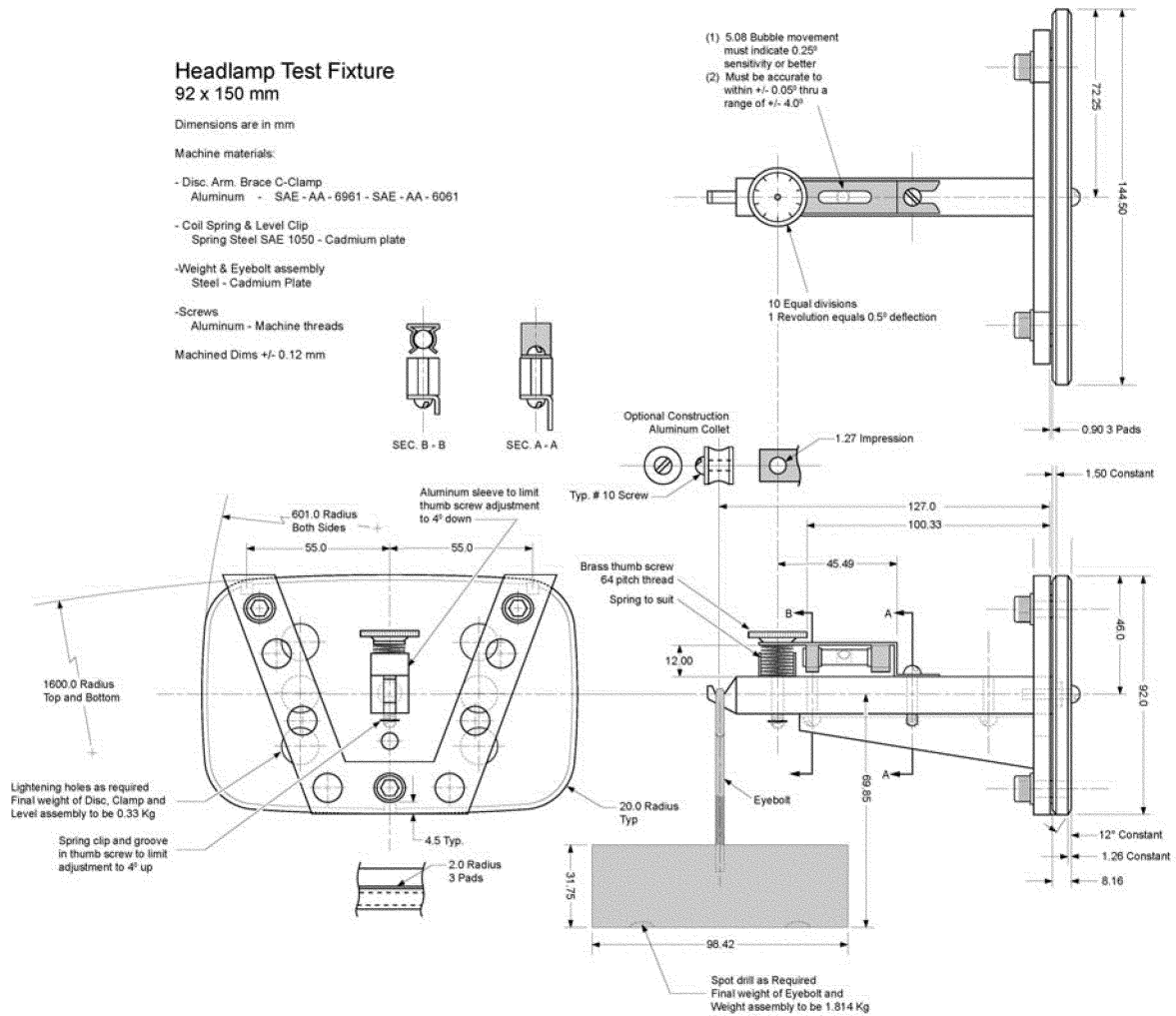

92 x 150 mm HEADLAMP AIM DEFLECTION TEST SETUP

FIGURE 14

Issued: July 27, 2011.

David L. Strickland,  
Administrator.

[FR Doc. 2011-19595 Filed 8-5-11; 8:45 am]

BILLING CODE 4910-59-C

Mr. Shigeyoshi Aihara  
Project Manager  
Regulation and Compliance  
Engineering Administration Department  
Ichikoh Industries, Ltd.  
80 Itado Ishehara City  
Kanagawa Pref.  
250-1192 Japan

Dear Mr. Aihara:

This is in reply to your letter of June 10, 1999, presented at a meeting with NHTSA representatives that day, asking for an interpretation of S5.1.2 of Federal Motor Vehicle Safety Standard No. 108. I am sorry that we were unable to provide you a response by July 6 as you requested in your letter of June 28 to Taylor Vinson of this Office.

Your company has developed a new rear turn signal lamp, consisting of an outer plastic lens, an inner cap, and an uncolored filament bulb. The color of the lens is "pale (light) pink color, and, this plastic material complies with the requirements of SAE J576c . . . excluding the color requirement." You tell us that the trichromaticity coordinates of the plastic material used in the outer lens do not fall within either the red or the white areas of the chromaticity chart of SAE J578c. However, when illuminated, the lamp provides an amber color that fall within the coordinates specified in SAE J578c. You have asked whether this design is acceptable under S5.1.2 relating to plastic materials used in optical parts of motor vehicle lighting devices.

Although this does not affect our answer to your question, please note, in Standard No. 108, that SAE Recommended Practice J576c of 1970 has been replaced by SAE J576 JUL91 as the applicable standard for plastic materials used in lighting devices. However, J578c remains the Federal standard for color.

We regret to inform you that this design is not acceptable. Although S1, *Scope*, of SAE J578c states that "The specification applies to the overall effective color of light emitted by the device," regardless of the color of its lens, both SAE J576 JUL91 and Standard No. 108 apply the color requirement to plastic components of lamps as well. S5.1.2(e) of Standard No. 108 requires the trichromatic coordinates of the plastic samples, tested according to that paragraph, to conform to the requirements of SAE J578c. Paragraphs 4.1 and 4.2.2 of SAE J576 JUL91 also require conformance of plastic samples to the chromaticity coordinate requirements of SAE J578c. This standard specifies color coordinates only for red, white, yellow (amber), green, and blue. Because the lens of your lamp does not meet any of the coordinates of SAE J578c, Standard No. 108 does not permit its use.

At the meeting, we noted that the inner lens was a greenish color. It, too, must comply with the color coordinate requirements of paragraphs 4.1 and 4.2.2 of SAE J576 JUL91.

At that time, you also asked if it were acceptable to use a plastic fabricated from the mix of two resins, each of which complied with the requirements of SAE J576. You cannot assume, when two complying resins are blended, that the resulting plastic will also comply with SAE J576 JUL91, and we recommend that you test the blended plastic to ensure that it meets all the specifications of S5.1.2 and SAE J576 JUL91. This would be the case whether it was the intent to create a new color, or whether the rejected molded parts are reground and plastics of differing compositions are mixed and recycled into newly-molded lamp lenses. As we said in the preamble to the 1995 final rule amending S5.1.2, "it is incumbent upon the vehicle or equipment manufacturer . . . not to change the composition of the plastics materials [obtained from the plastics manufacturer] in a manner that would cause it to be noncomplying." 60 FR 46066, copy enclosed.

Sincerely,  
Frank Seales, Jr.  
Chief Counsel  
Enclosure  
ref:108  
d.8/27/99

# KOITO

SHIZUOKA WORKS  
500, KITAWAKI  
SHIMIZU-SHI, SHIZUOKA-KEN  
JAPAN  
TEL NO. 0543-45-2573  
FAX NO. 0543-45-3437

DEPT. OF TRANSPORTATION  
POCKETS  
KOITO MANUFACTURING CO., LTD.

MAKERS



2005 OCT 12 A 11:27  
CONTRACTORS

HEAD OFFICE  
4-8-3, TAKANAWA  
MINATO-KU TOKYO  
JAPAN  
TEL NO. 03-3443-7111  
FAX NO. 03-3447-1520

4 August, 2005

U.S. Dept. of Transportation  
NHTSA  
Office of the Chief Counsel  
400 seventh Street SW  
Washington DC 20590

HTSA-05-22709-2

Request for Interpretation: Necessity of carrying out a 3-year outdoor exposure test

Dear Sir:

Koito would like to thank you in advance for your consideration of our request for an interpretation and clarification of the Federal Motor Vehicle Safety Standard (FMVSS) No.108 concerning the necessity of carrying out a 3-year outdoor exposure test in a certain combination of plastic and coating material as explained below.

**The Question:** Necessity of carrying out a 3-year outdoor exposure test when "material A", which is suitable for direct exposure of FMVSS108 S5.1.2 (b), is used with a covering lens "material B", also suitable for direct exposure of FMVSS108 S5.1.2 (b), and a coating material "a" which was originally on the exterior surface of "material A" is moved to the exterior surface of "material B".

We are contemplating a new combination of plastic lens and coating material for use in an inner lens optics of automotive lamps. In this hypothetical new combination, "material A" (polycarbonate), which is suitable for direct exposure of FMVSS108 S5.1.2 (b) after completion of the 3-year outdoor exposure test when used with coating material "a", is going to be used in the inner lens. "Material B" (polycarbonate), which is also suitable for direct exposure of FMVSS108 S5.1.2 (b), but without coating, is going to be used in the outer lens. Despite that both materials meet FMVSS108 S5.1.2(b) in direct exposure condition, coating material "a" which was originally on the exterior surface of the inner lens "material A" when performing a 3-year exposure test is going to be moved onto the exterior surface of the outer lens "material B", and material A loses the coating "a" from its own surface. (See Figure-1)

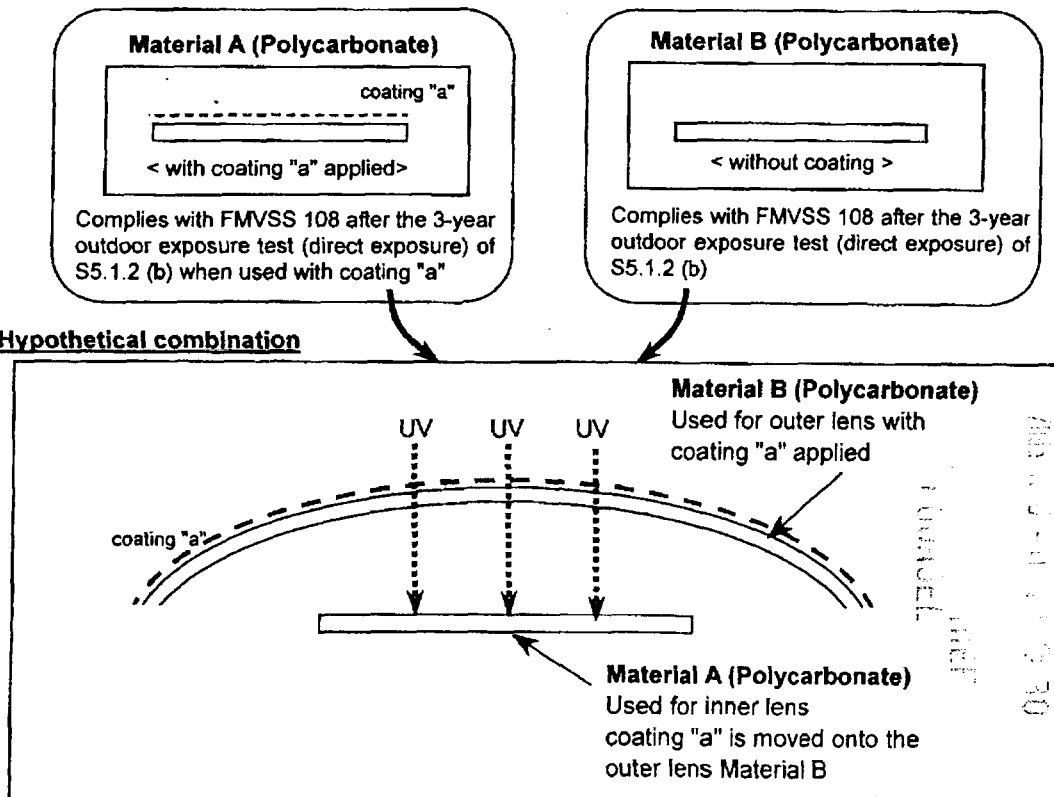

< Figure-1 >

We construe that no further testing of this hypothetical material / coating combination is required for the evaluation of the cumulative haze. Inner lens "material A" is still used with the coating material "a", although the coating itself is moved onto the exterior surface of the outer lens "material B". Also, in view of the vast reduction in ultraviolet exposure of inner lens which is afforded by the outer lens "material B", the inner lens "material A" would experience negligible haze when protected by an outer lens. This will further support the argument that haze performance of this material / coating combination is already ensured by the direct exposure of both materials A and B which were confirmed satisfactory to the FMVSS108 S5.1.2 (b) criteria after completion of the 3-year outdoor exposure tests.

Koito Manufacturing thanks you in advance for your early confirmation on this matter.

Sincerely,

A handwritten signature in black ink, appearing to read "K. Hyodo", with a horizontal line extending to the right.

Kiminori Hyodo  
Deputy General Manager, Regulation & Certification  
Koito Manufacturing Co., Ltd.



U.S. Department  
of Transportation  
**National Highway  
Traffic Safety  
Administration**

DEPT. OF TRANSPORTATION  
DOCKETS

OCT - 4 2005

2005 OCT 12 A 11:27

Docket SVC-124  
Std 108

400 Seventh St., S.W.  
Washington, D.C. 20590

NHTSA-05-22709-1

Mr. Kiminori Hyodo  
Deputy General Manager, Regulations & Certification  
Koito Manufacturing Co., Ltd.  
4-8-3, Takanawa  
Minato-ku Tokyo  
Japan

Dear Mr. Hyodo:

This responds to your recent letter, in which you asked whether it would be necessary to carry out a three-year, outdoor exposure test on a new combination of plastic lens and coating material under Federal Motor Vehicle Safety Standard (FMVSS) No. 108, Lamps, Reflective Devices, and Associated Equipment. Specifically, your letter stated that you plan to use two existing types of polycarbonate materials, each of which independently meets the requirements of S5.1.2 of Standard No. 108 (*i.e.*, Material A with a coating, and Material B without a coating). However, we understand that you now intend to combine these materials, such that Material A is used as an inner lens without a coating, and Material B is used as an outer lens with the same coating that had been applied to Material A. In response to your question, FMVSS No. 108 does not specifically require manufacturers to conduct testing, but it is the manufacturer's responsibility to produce a product that complies with all applicable requirements of our standard when tested in accordance with the standard, and to properly certify compliance.

By way of background, the National Highway Traffic Safety Administration (NHTSA) is authorized to issue FMVSSs that set performance requirements for new motor vehicles and items of motor vehicle equipment. NHTSA does not provide approval of motor vehicles or motor vehicle equipment. Instead, it is the responsibility of manufacturers to self-certify that their products conform to all applicable safety standards that are in effect on the date of manufacture (see 49 U.S.C. 30115 and 49 CFR Part 567, Certification).

We note further that the agency's safety standards specify the test conditions and procedures that NHTSA will use to evaluate the performance of the vehicle or equipment being tested for compliance with the particular safety standard. NHTSA follows the test procedures and conditions applicable and in effect at the time of certification when conducting its compliance testing.



VEHICLE SAFETY HOTLINE  
888-327-4236

A manufacturer is responsible for ensuring that its product complies with applicable standards when tested in accordance with NHTSA procedures. A manufacturer may choose a valid means other than NHTSA performance test procedures for evaluating its products to determine whether the vehicle or equipment will comply with the safety standards when tested by the agency according to the procedures specified by the standard and to provide a basis for its certification of compliance.

If the agency has reason to believe that an apparent noncompliance exists in a vehicle or item of motor vehicle equipment, the manufacturer is asked to show the basis for its certification that the vehicle or equipment complies with the relevant safety standard(s). If in fact the vehicle or equipment does not comply with a Federal motor vehicle safety standard when tested according to procedures specified by the standard, the manufacturer will have to recall the product to bring it into compliance at no charge to the customer.

In addition, the manufacturer will be subject to civil penalties, unless it can establish that it had no reason to know, despite exercising "reasonable care" in the design and manufacture of the product to ensure compliance, that the product did not in fact comply with the safety standard(s) (49 U.S.C. 30115(a) and 30165). This agency has long said that it is unable to judge what efforts would constitute "reasonable care" in advance of the actual circumstances in which a noncompliance occurs.

As you are aware, the requirements for lighting equipment are contained in FMVSS No. 108, which provides in relevant part:

S5.1.2 Plastic materials used for optical parts such as lenses and reflectors shall conform to SAE Recommended Practice J576 [Society of Automotive Engineers (SAE) Recommended Practice J576, Plastic Materials for Use in Optical Parts Such as Lenses and Reflex Reflectors of Motor Vehicle Lighting Devices] JUL91, except that:

- (a) Plastic lenses (other than those incorporating reflex reflectors) used for inner lenses or those covered by another material and not exposed directly to sunlight shall meet the requirements of paragraphs 3.3 and 4.2 of SAE J576 JUL91 when covered by the outer lens or other material;



- (b) After the outdoor exposure test, the haze and loss of surface luster of plastic materials (other than those incorporating reflex reflectors) used for outer lenses shall not be greater than 30 percent haze as measured by ASTM D 1003-92, *Haze and Luminous Transmittance of Transparent Plastic*;

...

- (g) All outdoor exposure tests shall be 3 years in duration, whether the material is exposed or protected. Accelerated weathering procedures are not permitted.

We note that neither SAE J576 nor Standard No. 108 specifically requires use of a coating.

Thus, the standard sets forth the test that NHTSA follows in conducting compliance testing. Specifically, under SAE J576 (incorporated by reference in FMVSS No. 108), the agency will subject plastic materials used for optical parts to an unaccelerated, three-year outdoor exposure test.

In short, Koito must ensure that its lamps as manufactured conform to all applicable requirements of FMVSS No 108, including that the plastic materials meet the exposure test requirements under S5.1.2. Again, our standards do not compel manufacturers to test the motor vehicles or motor vehicle equipment that they produce under NHTSA's test procedures, although many choose to do so in order to provide a basis for their certification. However, if the agency subjected the lamp in question to compliance testing, the lamp's plastic materials would need to meet the requirements of FMVSS No. 108, as certified.

If you have further questions, please feel free to contact Eric Stas of my staff at this address or by telephone at (202) 366-2992.

Sincerely,

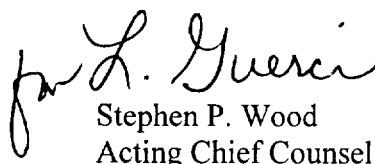
  
Stephen P. Wood  
Acting Chief Counsel

**HONDA**

American Honda Motor Co., Inc.  
1919 Torrance Boulevard  
Torrance, CA 90501-2746  
Phone (310) 783-2000

RECEIVED  
NYS-215

2004 JUN -1 A 9 51

OFFICE OF  
DEFECTS INVESTIGATION

04V-257  
(3 pages)

May 27, 2004

Mr. Kenneth N. Weinstein,  
Associate Administrator  
Office of Safety Assurance  
NATIONAL HIGHWAY TRAFFIC SAFETY  
ADMINISTRATION  
400 Seventh St., S.W.  
Washington, DC 20590

Dear Mr. Weinstein:

On May 20, 2004, Honda Motor Co., Ltd. (HMC) determined the existence of a noncompliance with Federal Motor Vehicle Safety Standard No. 108, "Lamps, Reflective Devices, and Associated Equipment" in the motor vehicles listed below. The following information is submitted pursuant to the requirements of 49 CFR 573.8.

573.8(c)(1)

<b>Name of manufacturer:</b>	Honda Motor Co., Ltd. (HMC)
<b>Manufacturer's agent:</b>	William R. Wilton American Honda Motor Co., Inc. (AHM) 1919 Torrance Blvd. Torrance, CA 90501-2746
<b>Name of tail lamp manufacturer:</b>	Kolto Manufacturing Co., Ltd.

573.8(c)(2)

**Identification of potentially affected vehicles:**

<u>Make/Model</u>	<u>Description</u>	<u>VIN/Dates of Manufacture</u>
Honda S2000	Certain 2000 models	JHMAP114*YT000049 - JHMAP114*YT007115 June 8, 1999 to April 5, 2000

**Description of the basis for the determination of the recall population:**

The 2000 model year was the introductory year of the S2000. The affected lenses of the side marker lamp and side reflex reflector in the tail lamp assembly were identified based on manufacturing records. The VIN range and manufacturing dates are inclusive of all vehicles that could potentially have a noncomplying lens installed by the factory.

573.8(c)(3)

**Total number of vehicles potentially affected:** 7,067

573.8(c)(4)

**Percentage of affected vehicles that contain the noncompliance:** Unknown

573.6(c)(5)

**Noncompliance description:**

**Summary**

The lens of the side marker lamp and side reflex reflector in the tail lamp assembly were manufactured with incorrect dye that, under the circumstances of use, does not retain its color over time and, therefore, does not comply with the requirements of Federal Motor Vehicle Safety Standard No. 108, "Lamps, Reflective Devices, and Associated Equipment."

**Detail**

The lens of the side marker lamp and side reflex reflector in the tail lamp assembly were manufactured using Diazole-base dye instead of Perinone-base dye. The chemical unit of Diazole-base dye, when used in the circumstances of the S2000, is more susceptible to UV and high temperature decomposition. As a result, the red color could fade, which does not comply with the deterioration requirement of Federal Motor Vehicle Safety Standard No. 108, "Lamps, Reflective Devices, and Associated Equipment."

573.6(c)(7)

**Determination of noncompliance:**

On June 17, 2003, HMC received a report that the color of the tail lamp side marker lens had faded. HMC initiated an investigation. According to Koito's accelerated test, the lens was projected to comply with the deterioration requirement of FMVSS 108. On May 14, 2004, Honda and Koito met with NHTSA to discuss compliance implications. In accordance with NHTSA's opinion, HMC determined the existence of a noncompliance.

573.6(c)(8)(i)

**Program for remedying the noncompliance:**

The owners of all affected vehicles will be notified by mail to take their vehicle to an authorized Honda dealer. The dealer will replace all affected tail lamp assemblies, free of charge.

573.6(c)(8)(ii)

<b>The estimated date to e-mail preliminary notification to dealers:</b>	Jun. 4, 2004
<b>The estimated date to provide service bulletin to dealers:</b>	Jun. 18, 2004
<b>The estimated date to begin sending notifications to owners:</b>	Jul. 7, 2004
<b>The estimated date of completion of the notification:</b>	Jul. 7, 2004

573.6(c)(9)

**Representative copies of all notices, bulletins and other communications:**

A copy of the dealer service bulletin and text of the final customer notification letter will be submitted to your office as soon as possible.

573.6(c)(10)

**Proposed owner notification letter submission:**

A draft of the owner notification letter will be submitted to your office as soon as possible.

Mr. Kenneth N. Weinstein  
May 27, 2004  
Page 3

573.6(c)(11)

**Manufacturer's campaign number:**

The number will be submitted to your office as soon as possible.

Sincerely,

AMERICAN HONDA MOTOR CO., INC.

A handwritten signature in black ink, appearing to read "William R. Willen", with a long horizontal flourish extending to the right.

William R. Willen  
Managing Counsel  
Product Regulatory Office

WRW:ka

Weaverville is located within the prohibited co-channel minimum distance separation of 280.8 kilometers (174.5 miles) to the Sacramento-Stockton television market, one of the designated television markets affected by the Commission's current freeze on allotments and applications pending the outcome of an inquiry into the use of advanced television systems in broadcasting. (See *Order, Advanced Television Systems and Their Impact on Existing Television Broadcasting Service*, 52 Fed. Reg. 28346, July 29, 1987). However, Channel 32 is allotted to Weaverville in compliance with the terms of the freeze *Order* at a restricted site. Interested parties should note that any application submitted for Channel 32 at Weaverville which does not specify a site beyond the "freeze zone" governing the allotment will not be accepted for filing.

#### List of Subjects in 47 CFR Part 73

Television broadcasting.

Part 73 of title 47 of the Code of Federal Regulations is amended as follows:

#### PART 73—[AMENDED]

1. The authority citation for part 73 continues to read as follows:

**Authority:** Secs. 303, 48 Stat., as amended, 1082; 47 U.S.C. 154, as amended.

#### § 73.606 [Amended]

2. Section 73.606(b), the Table of TV Allotments under California, is amended by adding Weaverville, Channel 32.

Federal Communications Commission.

**John A. Karousos,**

*Chief, Allocations Branch, Policy and Rules Division, Mass Media Bureau.*

[FR Doc. 95-21907 Filed 9-1-95; 8:45 am]

BILLING CODE 6712-01-F

---

## DEPARTMENT OF TRANSPORTATION

### National Highway Traffic Safety Administration

#### 49 CFR Part 571

[Docket No. 94-37; Notice 2]

RIN 2127-AF 22

#### Federal Motor Vehicle Safety Standards; Lamps, Reflective Devices and Associated Equipment

**AGENCY:** National Highway Traffic Safety Administration (NHTSA), DOT.

**ACTION:** Final rule.

**SUMMARY:** This notice adopts amendments to the Federal Motor

Vehicle Safety Standard on lighting to replace the currently incorporated SAE J576c with the more recent SAE J576 JUL91 as the referenced standard on plastics materials, to replace ASTM D 1003-61 with the more recent ASTM D 1003-92 in the test procedures, and to allow alternative processing techniques, sample sizes and thickness tolerances to those presently specified. These amendments represent the choice of Option 1 from the notice of proposed rulemaking published in November 1994.

**DATES:** The effective date of the final rule is March 1, 1996.

**FOR FURTHER INFORMATION CONTACT:** Kenneth O. Hardie, Office of Rulemaking, NHTSA (202-366-6987).

**SUPPLEMENTARY INFORMATION:** Heraeus DSET Laboratories, Inc. ("DSET"), of Phoenix, Arizona, petitioned NHTSA for rulemaking to amend Federal Motor Vehicle Safety Standard No. 108, *Lamps, Reflective Devices, and Associated Equipment*. Specifically, DSET asked that paragraph S5.1.2 be amended "to update the test specimen processing requirements of plastic material used for optical parts such as lenses and reflectors." Currently, these materials are required to conform to Society of Automotive Engineers (SAE) Recommended Practice J576c, May 1970. DSET wants NHTSA

to allow alternative processing techniques besides injection molding to produce test specimens, to allow test specimen sizes other than a 3 inch diameter disc and to change the specimen thickness tolerances from  $\pm 0.005$  inch to  $\pm 0.010$  inch.

Those requirements for injection molding and for the diameter and thickness of the test specimen are set forth in J576c, May 1970.

NHTSA granted the petition and published a notice of proposed rulemaking in response to it on November 2, 1994 (59 FR 54881). The notice proposed two alternative amendments of S5.1.2 as a means of implementing its grant of DSET's petition. The agency asked commenters for their views on each of the alternatives.

*Option 1.* This option would substitute SAE J576 JUL91 for SAE J576c, May 1970, and make conforming amendments in the text of S5.1.2. Option 1 would also replace American Society for Testing and Materials (ASTM) D 1003-61 with ASTM D 1003-92 with respect to measurement of haze (which, as currently specified, would not exceed 7 percent). A specimen thickness tolerance of  $\pm 0.25$  mm (0.010 in.) would also be allowed as there is no technical reason to limit the test

specimen thickness tolerance to  $\pm 0.005$  in., and the value proposed by NHTSA as recommended by DSET appears to be a more reasonable tolerance for test specimens.

*Option 2.* This option would retain the current SAE and ASTM specifications but would allow processing techniques other than injection molding to produce equivalent test specimens, test specimens other than a disc of 3-inch diameter, and a test specimen thickness tolerance of  $\pm 0.010$  inch.

Seven comments were received, five of which supported Option 1. These were from Flxible Corporation ("Flxible"), Transportation Safety Equipment Institute ("TSEI"), Robert Bosch, GmbH ("Bosch"), American Automobile Manufacturers Association ("AAMA"), and Ford Motor Company ("Ford"). Miles, Inc. opposed Option 1 and supported Option 2. The Plastics Division of General Electric Corporation ("GE") did not express a preference for either alternative.

Each of the commenters supporting Option 1 had a different concern. Flxible suggested that NHTSA adopt the base number of each SAE and ASTM standard/recommended practice, with the suffix notation "Latest Revision." In the company's view, this would eliminate the need to revise older materials and ensure that the safety standards reflect contemporary industry practice.

While this is an attractive notion, there are legal constraints against it. The SAE and ASTM materials per se are only guidelines and advisory in nature. Once they are incorporated into the Federal motor vehicle safety standards, they become "the law of the land", and a manufacturer must comply with them or face civil sanctions. Under the Administrative Procedure Act, a regulation imposing a substantive burden cannot be adopted in the absence of adequate public notice and an opportunity to comment. Under the approach suggested by Flxible, automatic updating of the safety standards to incorporate the latest SAE and ASTM revisions would occur with no prior public notice or opportunity to comment, and hence violate the Administrative Procedure Act. Further, NHTSA has found that many updated and revised materials change the previous materials in substantive ways. Some changes may not be in the interests of safety; the elimination of the heat test from SAE J576 JUL91 is one example of this. Other changes may increase, rather than reduce, a substantive burden upon industry. Regulated persons and the public must

be apprised of these changes before they are adopted.

NHTSA may, however, adopt an updated version without prior notice where there appears to be no substantive change since such an adoption is in the nature of a technical amendment. The agency is adopting an updated version in this final rule on the basis of a comment from TSEI. Under proposed paragraph S5.1.2(e), after exposure to the heat test, the samples shall conform to the color requirements of SAE J578a October 1966. TSEI pointed out that current paragraph S5.1.5 references SAE J578c February 1977. It recommended that NHTSA change both references to the specification of J578 MAY88.

NHTSA has compared the 1988 and 1977 versions of J578 with that of 1966. It finds no substantive difference between the 1966 and 1977 versions. The 1988 version, however, contains a third method of color measurement to be used "as a referee approach when the commonly used methods produce questionable results." In addition, the Appendix in the latter has added a section of "Color Measurements of Gaseous Discharge Lighting Devices." NHTSA ought to have comment on these changes before adopting SAE J578 MAY88, and, for this reason, has not followed TSEI's suggestion. On the other hand, because of the lack of substantive change between the other two versions, paragraph S5.1.2(e) is added with an update of the J578 reference to 1977 from the 1966 version which was proposed.

The wording of present paragraph S5.2.1 concerned Ford and AAMA. Under this paragraph, phrases such as "It is recommended that" and "should be," which appear in materials incorporated by reference, are to be read as setting forth mandatory requirements. Ford and AAMA commented that these phrases should not be interpreted as applying to SAE J576 JUL91. In NHTSA's view, the result of adopting Ford's and AAMA's comments would be to make compliance of plastic materials used for optical parts a voluntary affair. This would defeat the purpose of the rulemaking.

Proposed paragraph S5.1.2(e) would require test samples, after the heat test, to "show no discernable change in shape and general appearance when compared with an unexposed specimen." This language comes from J576 itself, with the exception that the SAE uses "significant" rather than "discernable." Ford and AAMA objected to this substitution, arguing that it would establish a higher standard to be met by plastics, and that there is

no need to change language that has been a requirement for years. They recommended use of the word "significant." In their view, a change that is "discernable" is not necessarily one that is "significant."

In its proposal, NHTSA had no intention of increasing the burden on any regulated party. The agency proposed the word "discernable" with care, because it is objective, while "significant" is not. Motor vehicle safety standards are required by law to be "objective", 49 U.S.C. 30111(a). The agency has concluded that "discernable" is more appropriate for a requirement specifically expressed in the text of Standard No. 108 (as compared with one incorporated by reference). However, NHTSA wishes to make clear that it views the words as essentially synonymous in this context. If a post-test change in shape or general appearance is discernable, NHTSA considers that to be significant. Such a change indicates the potential for degradation of a lens in use, with a corresponding effect upon color and photometrics of the lamp on which it is installed. To add even greater objectivity, the final rule expresses the requirement as "discernable to the naked eye." Should a change be discernable to the naked eye after testing, and a manufacturer believe that such a change is not "significant," the manufacturer may file a Part 573 Noncompliance Notification Report simultaneously with an application to NHTSA for a determination that the change resulting from that testing is inconsequential to motor vehicle safety.

GE did not choose between the alternatives in its comment. It did, however, recommend the adoption of SAE J576 JUL91 in its entirety, and that NHTSA not carry over the heat test from the previous version of J576. In its view, the heat tests of SAE J575 are adequate until further work is done on thermal issues suitable for incorporation into J576.

Having considered the comments in response to the NPRM, NHTSA is amending Standard No. 108 to add the two new paragraphs proposed, maintaining the performance requirements required of plastic materials by SAE J576c for the heat test and specifying positioning of test samples during the test. These have been omitted by the SAE from J576 JUL91. NHTSA has chosen to retain the existing heat test as one that is familiar to industry and one which meets the need for motor vehicle safety. It is a minimum requirement, intended to establish a margin of safety between the temperatures at which plastic reflectors

and lenses may fail from internal heat, and temperatures on the exterior surface induced by exposure to sunlight. Lamp manufacturers use J575 or similar tests to determine whether the particular design characteristics of their lamps require use of premium materials in the lenses. It is a test of the finished lens as installed on the lamp, rather than a test of the materials used in finished products. Use of material with insufficient high temperature performance can result in reflectors that lose color and reflectivity.

The positioning of test samples will allow the sample to droop if its strength is adversely affected by the test.

In order to retain the current 3-year outdoor exposure time test requirements for plastic lenses used or covered by another material and not exposed directly to sunlight, NHTSA is adding a new paragraph S5.1.2(g) to specify that paragraph 3.3.3.1 of SAE J576 JUL91 does not apply as regards protected materials. For the same reason, NHTSA is not adopting paragraph 3.3.3.2. of SAE J576 JUL91 which allows an accelerated 6-month outdoor exposure test time. New paragraph S5.1.2(g) will not change the stringency or flexibility of the standard as it exists, but will ensure that the integrity of plastic materials is maintained by not permitting a lesser exposure time for materials which may be protected when in use.

Miles, Inc., a manufacturer of polycarbonate resin used as a material in lenses and reflectors, objected to Option 1. In its view, this alternative places an additional testing burden on the resin manufacturer, as compared with the present requirements. For this reason, it supported Option 2. Specifically, Miles opposes SAE J576 JUL91 because of Section 3.1 *Materials to be Tested*. This section reads:

Outdoor exposure tests shall be made on each material \* \* \* offered for use in optical parts \* \* \*. Concentrations of polymer components and additives such as plasticizer, lubricants, colorants, weathering stabilizers, and antioxidants in plastic materials and/or coatings may be changed without outdoor exposure testing if: the changes are within the limits of composition represented by higher and lower concentrations of these polymer components and additives have been tested in accordance with 3.3 and found to meet the requirements of Section 4.

Miles interprets this language to mean that changes in dye concentrations would only be permissible if samples containing lower and higher concentrations of dye had been exposure tested. Miles believes that this, in effect, would double the samples to

be tested when compared with the present requirements.

The present requirements are those of section 3.1 of SAE J576c, May 1970. These state, in pertinent part, that "[a] test of one color and formulation shall cover variations in dye concentration, but shall not cover changes in dye materials or changes in polymers." Miles interprets this as meaning that a new exposure test need not be conducted under the 1970 version if the only change in the product is a variation in dye concentration. Its present practice is to test for exposure materials incorporating new dyes only at the expected concentration level of the dye. One exposure test covers each new dye, but Miles will accept the test results as valid when there are small variations in dye concentration.

Miles is correct that SAE J576c allows a single test to cover variations in dye concentration. SAE J576 JUL91 may be interpreted as calling for the testing of two samples by specifying that dye concentrations in material to be used in motor vehicle optical parts must fall within the upper and lower limits of dye concentrations tested if there are variations in dye concentration. Miles believes the newer requirement will double its testing burden.

NHTSA does not agree that this is the inevitable result of the adoption of this portion of SAE J576 JUL 91. What paragraph S5.1.2 is intended to ensure is that lenses and reflectors, as manufactured for use on motor vehicles, are fabricated from plastic materials that meet SAE J576. The key issue is whether the equipment satisfies the performance requirements of the standard, not the number of tests conducted on the materials used in the equipment. Ultimately, the manufacturer of the vehicle in certifying compliance with all applicable Federal motor vehicle safety standards, is certifying that the lenses and reflectors on the vehicle are made from plastics materials that meet J576. If the lens or reflector is manufactured as replacement equipment, the certification responsibility is that of the manufacturer of the equipment. Thus, it is incumbent upon the vehicle or equipment manufacturer to assure itself that the materials it obtains from the plastics manufacturer comply with SAE J576 (and, furthermore, not to change the composition of the plastics materials so obtained in a manner that would cause it to be noncomplying). The documentation needed for such assurance, including the quantum of testing performed by the plastics manufacturer and by the vehicle or equipment manufacturer, is a decision

that each equipment or vehicle manufacturer must make under the particular circumstances. NHTSA, of course, expects manufacturers to exercise reasonable care in certifying their products, and, in the event of a noncompliance, the manufacturer may claim that it had no reason to know, despite exercising reasonable care, that the vehicle or equipment failed to comply. However, the allocation of that responsibility is a matter of contract between the manufacturer with the Federal certification responsibility and its plastic materials supplier. Plastic materials are not completed items of motor vehicle equipment subject to Standard No. 108 so the Federal certification responsibility does not fall upon Miles. If Miles or other materials manufacturers are satisfied, based on their extensive experience with dyes, that changes in dye concentration would not cause the plastic material to fail the specified performance requirements, they may be able to persuade their purchasers that additional testing is not needed.

#### Effective Date

The effective date of the final rule is March 1, 1996.

#### Rulemaking Analyses and Notices

*Executive Order 12866 and DOT Regulatory Policies and Procedures.* This final rule was not reviewed under Executive Order 12866. It has been determined that the rulemaking action is not significant under Department of Transportation regulatory policies and procedures. The purpose of the rulemaking action is to update testing procedures. Since the final rule will have no significant cost or other impacts, preparation of a full regulatory evaluation is not warranted.

*National Environmental Policy Act.* NHTSA has analyzed this rulemaking action for the purposes of the National Environmental Policy Act. The final rule will not have a significant effect upon the environment. The composition of plastic materials used in optical parts will not change from those presently in production.

*Regulatory Flexibility Act.* The agency has also considered the impacts of this rulemaking action in relation to the Regulatory Flexibility Act. I certify that this rulemaking action does not have a significant economic impact upon a substantial number of small entities. Accordingly, no regulatory flexibility analysis has been prepared. Manufacturers of motor vehicles and motor vehicle equipment, those affected by the rulemaking action, are generally not small businesses within the

meaning of the Regulatory Flexibility Act. Further, small organizations and governmental jurisdictions will not be significantly affected because the price of new vehicles and vehicle equipment will not be impacted.

*Executive Order 12612 (Federalism).* This rulemaking action has also been analyzed in accordance with the principles and criteria contained in Executive Order 12612, and NHTSA has determined that this rulemaking action does not have sufficient Federalism implications to warrant the preparation of a federalism Assessment.

*Civil Justice.* The final rule will not have any retroactive effect. Under 49 U.S.C. 30103, whenever a Federal motor vehicle safety standard is in effect, a state may not adopt or maintain a safety standard applicable to the same aspect of performance which is not identical to the Federal standard. 49 U.S.C. 30161 sets forth a procedure for judicial review of final rules establishing, amending or revoking Federal motor vehicle safety standards. That section does not require submission of a petition for reconsideration or other administrative proceedings before parties may file suit in court.

#### List of Subjects in 49 CFR Part 571

Imports, Motor vehicle safety, Motor vehicles

#### PART 571—FEDERAL MOTOR VEHICLE SAFETY STANDARDS

In consideration of the foregoing, 49 CFR part 571 is amended as follows:

1. The authority citation for part 571 continues to read as follows:

**Authority:** 49 U.S.C. 322, 30111, 30115, 30117 and 30166; delegation of authority at 49 CFR 1.50.

2. Section 571.108 is amended by revising paragraph S5.1.2, to read as follows:

#### § 571.108 Motor Vehicle Safety Standard No. 108; Lamps, reflective devices, and associated equipment.

\* \* \* \* \*

S5.1.2 Plastic materials used for optical parts such as lenses and reflectors shall conform to SAE Recommended Practice J576 JUL91, except that:

(a) Plastic lenses (other than those incorporating reflex reflectors) used for inner lenses or those covered by another material and not exposed directly to sunlight shall meet the requirements of paragraphs 3.3 and 4.2 of SAE J576 JULY91 when covered by the outer lens or other material;

(b) After the outdoor exposure test, the haze and loss of surface luster of

plastic materials (other than those incorporating reflex reflectors) used for outer lenses shall not be greater than 30 percent haze as measured by ASTM D 1003-92, *Haze and Luminous Transmittance of Transparent Plastic*;

(c) After the outdoor exposure test, plastic materials used for reflex reflectors and for lenses used in front of reflex reflectors shall not show surface deterioration, crazing, dimensional changes, color bleeding, delamination, loss of surface luster, or haze that exceeds 7 percent as measured under ASTM D 1003-92.

(d) The thickness of the test specimens specified in paragraph 3.2.2 of SAE J576 JUL91 may vary by as much as  $\pm 0.25$  mm.

(e) After exposure to the heat test as specified in subparagraph (f) of this paragraph, and after cooling to room ambient temperature, a test specimen shall show no change in shape and general appearance discernable to the naked eye when compared with an unexposed specimen. The trichromatic coefficients of the samples shall conform to the requirements of SAE J578c, "Color Specification for Electric Signal Lighting Devices", February 1977.

(f) Two samples of each thickness of each plastic material are used in the heat test. Each sample is supported at the bottom, with at least 51 mm. of the sample above the support, in the vertical position in such a manner that, on each side, the minimum uninterrupted area of exposed surface is not less than 3225 sq. mm. The samples are placed for two hours in a circulating air oven at  $79 \pm 3$  degrees C.

(g) All outdoor exposure tests shall be 3 years in duration, whether the material is exposed or protected. Accelerated weathering procedures are not permitted.

\* \* \* \* \*

Issued on August 29, 1995.

**Ricardo Martinez,**  
*Administrator.*

[FR Doc. 95-21865 Filed 9-1-95; 8:45 am]  
BILLING CODE 4910-59-P

## DEPARTMENT OF COMMERCE

### National Oceanic and Atmospheric Administration

#### 50 CFR Part 672

[Docket No. 950206041-5041-01; I.D. 082895A]

#### Groundfish of the Gulf of Alaska; Pacific Cod with Jig and Pot Gear for Processing by the Inshore Component in the Central Regulatory Area

**AGENCY:** National Marine Fisheries Service (NMFS), National Oceanic and Atmospheric Administration (NOAA), Commerce.

**ACTION:** Modification of a closure.

**SUMMARY:** NMFS is opening directed fishing for Pacific cod by vessels catching Pacific cod with jig and pot gear for processing by the inshore component in the Central Regulatory Area of the Gulf of Alaska (GOA). This action is necessary to use the total allowable catch (TAC) for Pacific cod in this area.

**EFFECTIVE DATE:** 12 noon, Alaska local time (A.l.t.), September 1, 1995, until 12 midnight, A.l.t., December 31, 1995.

**FOR FURTHER INFORMATION CONTACT:** Andrew N. Smoker, 907-586-7228.

**SUPPLEMENTARY INFORMATION:** The groundfish fishery in the GOA exclusive economic zone is managed by NMFS according to the Fishery Management Plan for Groundfish of the Gulf of Alaska (FMP) prepared by the North Pacific Fishery Management Council under authority of the Magnuson Fishery Conservation and Management Act. Fishing by U.S. vessels is governed by regulations implementing the FMP at 50 CFR parts 620 and 672.

In accordance with § 672.20(c)(1)(ii)(B), the allocation of Pacific cod for the inshore component in the Central Regulatory Area of the GOA was established by the Final 1995 Harvest Specifications of Groundfish (60 FR 8470, February 14, 1995) as 41,085 metric tons (mt). The directed fishery for Pacific cod by vessels catching Pacific cod for processing by the inshore component in the Central Regulatory Area of the GOA was closed under § 672.20(c)(2)(ii) on March 22, 1995, in order to reserve amounts anticipated to be needed for incidental catch in other fisheries (60 FR 15521, March 24, 1995). NMFS has determined that as of August 8, 1995, 4,313 mt remain unharvested.

The Director, Alaska Region, NMFS, has determined that the 1995 TAC for Pacific cod for processing by the inshore component in the Central Regulatory Area of the GOA has not been reached.

Therefore, NMFS is terminating the previous closure and is opening directed fishing for Pacific cod by vessels catching Pacific cod for processing by the inshore component in the Central Regulatory Area of the GOA. All other closures remain in full force and effect.

This action opens the directed fishery for Pacific cod by vessels catching Pacific cod with jig and pot gear for processing by the inshore component in the Central Regulatory Area of the GOA. Directed fishing for groundfish with hook-and-line and trawl gear is currently prohibited (60 FR 26694, May 18, 1995; 60 FR 37600, July 21, 1995; 60 FR 37601, July 21, 1995).

#### Classification

This action is taken under 50 CFR 672.20 and is exempt from review under E.O. 12866.

**Authority:** 16 U.S.C. 1801 *et seq.*

Dated: August 29, 1995.

**Richard H. Schaefer,**

*Director, Office of Fisheries Conservation and Management, National Marine Fisheries Service.*

[FR Doc. 95-21948 Filed 8-30-95; 3:43 pm]

BILLING CODE 3510-22-F

#### 50 CFR Part 672

[Docket No. 950206041-5041-01; I.D. 082995A]

#### Groundfish of the Gulf of Alaska; Trawling in the Western Regulatory Area

**AGENCY:** National Marine Fisheries Service (NMFS), National Oceanic and Atmospheric Administration (NOAA), Commerce.

**ACTION:** Inseason adjustment; request for comments.

**SUMMARY:** NMFS issues an inseason adjustment closing the season for all groundfish by vessels using trawl gear, except fishing for pollock by vessels using pelagic trawl gear, in the Western Regulatory Area of the Gulf of Alaska (GOA). This action is necessary to prevent overfishing of Pacific ocean perch (POP).

**DATES:** Effective 12 noon, Alaska local time (A.l.t.), September 1, 1995, until 12 midnight, A.l.t., December 31, 1995. Comments must be received no later than 4:30 p.m., A.l.t., September 18, 1995.

**ADDRESSES:** Comments may be sent to Ronald J. Berg, Chief, Fisheries Management Division, Alaska Region, NMFS, P.O. Box 21668, Juneau, AK 99802, Attn. Lori Gravel, or be delivered



Mr. Shigeyoshi Aihara  
Project Manager  
Regulation and Compliance  
Engineering Administration Department  
Ichikoh Industries, Ltd.  
80 Itado Ishehara City  
Kanagawa Pref.  
250-1192 Japan

Dear Mr. Aihara:

This is in reply to your letter of June 10, 1999, presented at a meeting with NHTSA representatives that day, asking for an interpretation of S5.1.2 of Federal Motor Vehicle Safety Standard No. 108. I am sorry that we were unable to provide you a response by July 6 as you requested in your letter of June 28 to Taylor Vinson of this Office.

Your company has developed a new rear turn signal lamp, consisting of an outer plastic lens, an inner cap, and an uncolored filament bulb. The color of the lens is "pale (light) pink color, and, this plastic material complies with the requirements of SAE J576c . . . excluding the color requirement." You tell us that the trichromaticity coordinates of the plastic material used in the outer lens do not fall within either the red or the white areas of the chromaticity chart of SAE J578c. However, when illuminated, the lamp provides an amber color that fall within the coordinates specified in SAE J578c. You have asked whether this design is acceptable under S5.1.2 relating to plastic materials used in optical parts of motor vehicle lighting devices.

Although this does not affect our answer to your question, please note, in Standard No. 108, that SAE Recommended Practice J576c of 1970 has been replaced by SAE J576 JUL91 as the applicable standard for plastic materials used in lighting devices. However, J578c remains the Federal standard for color.

We regret to inform you that this design is not acceptable. Although S1, *Scope*, of SAE J578c states that "The specification applies to the overall effective color of light emitted by the device," regardless of the color of its lens, both SAE J576 JUL91 and Standard No. 108 apply the color requirement to plastic components of lamps as well. S5.1.2(e) of Standard No. 108 requires the trichromatic coordinates of the plastic samples, tested according to that paragraph, to conform to the requirements of SAE J578c. Paragraphs 4.1 and 4.2.2 of SAE J576 JUL91 also require conformance of plastic samples to the chromaticity coordinate requirements of SAE J578c. This standard specifies color coordinates only for red, white, yellow (amber), green, and blue. Because the lens of your lamp does not meet any of the coordinates of SAE J578c, Standard No. 108 does not permit its use.

At the meeting, we noted that the inner lens was a greenish color. It, too, must comply with the color coordinate requirements of paragraphs 4.1 and 4.2.2 of SAE J576 JUL91.

At that time, you also asked if it were acceptable to use a plastic fabricated from the mix of two resins, each of which complied with the requirements of SAE J576. You cannot assume, when two complying resins are blended, that the resulting plastic will also comply with SAE J576 JUL91, and we recommend that you test the blended plastic to ensure that it meets all the specifications of S5.1.2 and SAE J576 JUL91. This would be the case whether it was the intent to create a new color, or whether the rejected molded parts are reground and plastics of differing compositions are mixed and recycled into newly-molded lamp lenses. As we said in the preamble to the 1995 final rule amending S5.1.2, "it is incumbent upon the vehicle or equipment manufacturer . . . not to change the composition of the plastics materials [obtained from the plastics manufacturer] in a manner that would cause it to be noncomplying." 60 FR 46066, copy enclosed.

Sincerely,  
Frank Seales, Jr.  
Chief Counsel  
Enclosure  
ref:108  
d.8/27/99

Docket SVC-124  
Std 108



U.S. Department  
of Transportation  
**National Highway  
Traffic Safety  
Administration**

MAR 27 2009

1200 New Jersey Avenue SE.  
Washington, DC 20590

DEPT OF TRANSPORTATION  
DOCKET

MAR 10 A 10 10

Mr. Kiminori Hyodo  
Deputy General Manager, Regulation & Certification  
Koito Manufacturing Co., Ltd.  
4-8-3, Takanawa  
Minato-Ku Tokyo  
Japan

Dear Mr. Hyodo:

This responds to your letter, in which you ask about test requirements for plastic materials for use in lenses under Federal Motor Vehicle Safety Standard (FMVSS) No. 108, Lamps, Reflective Devices, and Associated Equipment. Specifically, you asked whether you could exclude the presence of metal particles contained within a plastic lens from the outdoor exposure test incorporated by reference into Standard No. 108. You also asked what the term "lens" means under S5.1.2 of FMVSS No. 108. Our responses are presented below.

By way of background, the National Highway Traffic Safety Administration (NHTSA) is authorized to issue FMVSSs that set performance requirements for new motor vehicles and items of motor vehicle equipment (see 49 U.S.C. Chapter 301). NHTSA does not provide approvals of motor vehicles or motor vehicle equipment. Instead, manufacturers are required to self-certify that their products conform to all applicable safety standards that are in effect on the date of manufacture. NHTSA selects a sampling of new vehicles and regulated equipment each year to determine their compliance with applicable FMVSSs. If our testing or examination reveals an apparent noncompliance, we may require the manufacturer to remedy the noncompliance, and may initiate an enforcement proceeding if necessary to ensure that the manufacturer takes appropriate action.

Do the metal particles need to be included in the "haze test?"

Your first question relates to the presence of a layer of metal particles on the lens. According to your letter, a process called "half-metalization" allows you to create a semitransparent metallic layer on your lens, between the lens and a protective coating. This half-metalized layer effectively reduces light transmission to about 30% of a non-metalized lens.



As you state in your letter, FMVSS No. 108 requires that optical parts be certified to comply with the testing procedures in SAE Recommended Practice J576 (JUL 91), "Plastic Materials for use in Optical Parts such as Lenses and Reflex Reflectors of Motor Vehicle Lighting Devices," incorporated by reference into paragraph S5.1.2 of the standard. Part of this practice specifies that materials be subject to a three year outdoor exposure test. Your specific question asked if you could exclude the presence of the metal particles from the three year exposure test. In asking this question, you state that metals are inorganic and do not excite plastics and also, since half-metalization is applied on the inner surface and protected by the coating, it would not be oxidized.

In responding to your question as to whether you can exclude the metal particles from the test, we note that each of this agency's safety standards specifies the test conditions and procedures that this agency will use to evaluate the performance of the vehicle or equipment being tested for compliance with the particular safety standard. NHTSA follows these specified test procedures and conditions when conducting its compliance testing.

Manufacturers are not required to test their products in the manner specified in the relevant safety standard, or even to test the product at all, as their basis for certifying that the product complies with all relevant standards. A manufacturer may choose any valid means of evaluating its products to determine whether the vehicle or equipment will comply with the safety standards when tested by the agency according to the procedures specified in the standard and to provide a basis for its certification of compliance.

If we tested this product, the outdoor exposure test would include the presence of the metal particles. There is nothing in FMVSS No. 108, including the relevant items incorporated by reference, that specifies excluding the particles. We also note that much like protective coatings, these particles have a substantial effect on the transparency and endurance of the lens, and we therefore believe they should be included as part of the lens in all relevant test requirements.

#### Definition of the term "lens"

Your second question concerned the definition of the term "lens" under S5.1.2 of FMVSS No. 108, and whether that definition would include a half-metalized area surrounding the effective projected luminous lens area. You stated that the non-metalized portion of the lens would meet all photometric requirements of the standard, and that it would be surrounded by a half-metalized portion of the lens, which would emit only a small amount of light for decorative purposes.

The term "lens," while not explicitly defined in Standard No. 108, is commonly understood within automotive lighting lamp applications as a component of a lamp that as installed allows light to pass through it. For the purposes of S5.1.2, all plastic portions of this component that allow light to pass through it are part of the "lens," subject to the haze test, including the half-metalized area that you state would emit a small amount of light.

Are the non-EPLLA portions of the lens subject to the S5.1.2 requirements?

You followed up your second question by asking, "when half-metalization is applied only to the part surrounding the effective projected luminous lens area, would it be excluded from [the] S5.1.2 requirement?" Our answer is no.

It is our opinion that all portions of the lens, including the half-metalized areas that only emit small amounts of light for decorative purposes, are subject to the requirements of S5.1.2, which specify haze and weathering requirements similar to those described in SAE Recommended Practice J576.

The language of S5.1.2 reads, "Plastic materials used for optical parts such as lenses and reflectors shall conform to [SAE J576]...." When testing plastic materials, however, the agency does not simply test a plastic plaque alone. Instead, the plastic plaque is tested with its coating, which frequently is necessary to protect the plastic from the effects of weathering. The coating on the plastic is an integral feature in protecting the plastic from moisture, ultraviolet light, and other agents.

You described your lens as having a semitransparent metallic layer between the lens and the coating. In addition to the effect this has on the transparency of that portion of the lens, it may also affect the weathering aspects. For example, if the metal layer affected the bonding of the coating to the plastic, it could have substantial affect on whether the lens could tolerate weathering.

Because, as described above, the lens is a single piece, if even a decorative, half-metalized portion of the lens were to fail the weathering requirements in S5.1.2, it could have a substantial affect on the entire lens. For example, moisture could enter the lens, affecting the non-metalized portion's transparency.

For these reasons, when testing the lens you described, the half-metalized portion of the lamp design described in your letter would be included as an item subject to the testing requirements of S5.1.2 of FMVSS No. 108.

If you have any further questions, please contact Ari Scott of my staff at (202) 366-2992.

Sincerely yours,



Stephen P. Wood  
Acting Chief Counsel



**Question No.2: What the term "lens" means under S5.1.2. of FMVSS108?**

S5.1.2. of FMVSS108 requires that plastic materials used for optical parts such as lenses and reflectors shall conform to SAE J576 JUL91. Does the term "lens" under S5.1.2. indicate the effective part of the lens (corresponding to the effective projected luminous lens area) only, or whole part of the lens?

In conjunction with above question, when half-metalization is applied only to the part surrounding the effective projected luminous lens area, would it be excluded from S5.1.2. requirement? (In this case, of course, photometric requirements will be met by the effective projected luminous lens area only, and the half-metalized part slightly emits light for decorative purpose.)

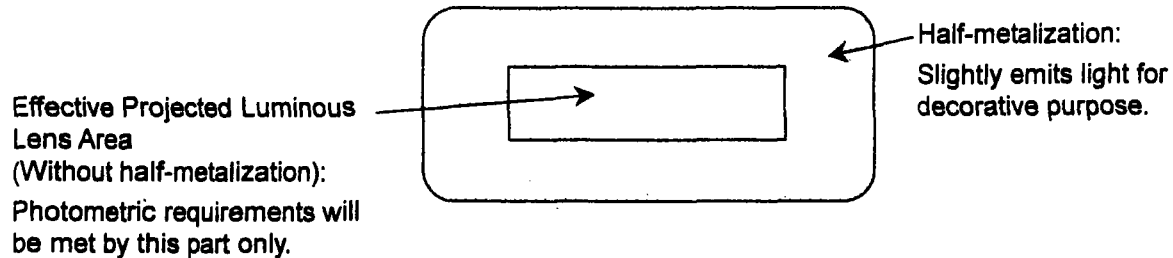

< Figure 2: Half-metalization outside EPLLA >

Koito Manufacturing thanks you in advance for your early confirmation on this matter.

Sincerely,

Kiminori Hyodo  
Deputy General Manager, Regulation & Homologation  
Koito Manufacturing Co., Ltd.

were amended in 2005. Reinstating the specific language in the regulations will therefore not increase the paperwork burden on those manufacturers.

#### H. Executive Order 13045

Executive Order 13045 applies to any rule that (1) is determined to be “economically significant” as defined under E.O. 12866, and (2) concerns an environmental, health, or safety risk that NHTSA has reason to believe may have a disproportionate effect on children. If the regulatory action meets both criteria, we must evaluate the environmental health or safety effects of the planned rule on children, and explain why the planned rule is preferable to other potentially effective and reasonably feasible alternatives considered by us. This rulemaking is not economically significant and does not concern an environmental, health, or safety risk.

#### I. National Technology Transfer and Advancement Act

Section 12(d) of the National Technology Transfer and Advancement Act of 1995 (NTTAA), Public Law 104–113, section 12(d) (15 U.S.C. 272) directs NHTSA to use voluntary consensus standards in its regulatory activities unless doing so would be inconsistent with applicable law or otherwise impractical. Voluntary consensus standards are technical standards (e.g., materials specifications, test methods, sampling procedures, and business practices) that are developed or adopted by voluntary consensus standards bodies, such as the Society of Automotive Engineers (SAE). The NTTAA directs the agency to provide Congress, through the OMB, with explanations when we decide not to use available and applicable voluntary consensus standards.

In this final rule, we are adding to 49 CFR 576.4(g)(5) the requirement that manufacturers include in the certification labels that they affix to certain types of motor vehicles a statement certifying that the vehicle conforms to all applicable FMVSS. This language was inadvertently omitted from the regulation in 2005 and we are adopting no substantive changes to the regulation nor do we propose any technical standards. For these reasons, Section 12(d) of the NTTAA would not apply.

#### J. Regulation Identifier Number (RIN)

The Department of Transportation assigns a regulation identifier number (RIN) to each regulatory action listed in the Unified Agenda of Federal Regulations. The Regulatory Information Service Center publishes the Unified

Agenda in April and October of each year. You may use the RIN contained in the heading at the beginning of this document to find this action in the Unified Agenda.

#### List of Subjects in 49 CFR Part 567

Labeling, Motor vehicle safety, Motor vehicles.

In consideration of the foregoing, Part 567, Certification, in Title 49 of the Code of Federal Regulations is amended as follows:

#### PART 567—CERTIFICATION

■ 1. The authority citation for part 567 is revised to read as follows:

**Authority:** 49 U.S.C. 322, 30111, 30115, 30117, 30166, 32502, 32504, 33101–33104, 33108, and 33109; delegation of authority at 49 CFR 1.95.

■ 2. Amend § 567.4 by adding paragraph (g)(5)(iv) to read as follows:

#### § 567.4 Requirements for manufacturers of motor vehicles.

\* \* \* \* \*

(g) \* \* \*

(5) \* \* \*

(iv) For all other vehicles, the statement: “This vehicle conforms to all applicable Federal motor vehicle safety standards in effect on the date of manufacture shown above.” The expression “U.S.” or “U.S.A.” may be inserted before the word “Federal”.

\* \* \* \* \*

Issued on: November 28, 2012.

**Daniel C. Smith,**

Senior Associate Administrator for Vehicle Safety.

[FR Doc. 2012–29132 Filed 12–3–12; 8:45 am]

**BILLING CODE 4910–59–P**

#### DEPARTMENT OF TRANSPORTATION

#### National Highway Traffic Safety Administration

#### 49 CFR Part 571

[Docket No. NHTSA–2012–0171]

RIN 2127–AK99

#### Federal Motor Vehicle Safety Standards; Lamps, Reflective Devices, and Associated Equipment

**AGENCY:** National Highway Traffic Safety Administration (NHTSA), Department of Transportation (DOT).

**ACTION:** Final rule.

**SUMMARY:** NHTSA is amending the Federal motor vehicle safety standard (FMVSS) on lamps, reflective devices, and associated equipment to restore the

blue and green color boundaries that were removed when the agency published a final rule reorganizing that standard on December 4, 2007.

**DATES:** Effective date: December 4, 2012.

*Petitions for reconsideration:* Petitions for reconsideration of this final rule must be received not later than January 18, 2013.

**ADDRESSES:** Any petitions for reconsideration should refer to the docket number of this document and be submitted to: Administrator, National Highway Traffic Safety Administration, 1200 New Jersey Avenue SE, West Building, Ground Floor, Docket Room W12–140, Washington, DC 20590.

**FOR FURTHER INFORMATION CONTACT:** For technical issues: Ms. Marisol Medri, Office of Crash Avoidance Standards, NHTSA, 1200 New Jersey Avenue SE, West Building, Washington, DC 20590 (Telephone: (202) 366–6987) (Fax: (202) 366–7002).

For legal issues: Mr. Thomas Healy, Office of the Chief Counsel, NHTSA, 1200 New Jersey Avenue SE, West Building, Washington, DC 20590 (Telephone: (202) 366–2992) (Fax: (202) 366–3820).

#### SUPPLEMENTARY INFORMATION:

#### I. Background

FMVSS No. 108, *Lamps, Reflective Devices and Associated Equipment*, has been in existence since 1968. The standard had been amended on an *ad hoc* basis over time resulting in a patchwork organization of the standard. NHTSA published a final rule on December 4, 2007,<sup>1</sup> amending FMVSS No. 108 by reorganizing the regulatory text so that it provides a more straightforward and logical presentation of the applicable regulatory requirements; incorporating important agency interpretations of the existing requirements; and reducing reliance on third-party documents incorporated by reference. The preamble of the final rule stated that the rewrite of FMVSS No. 108 was administrative in nature and would have no impact on the substantive requirements of the standard. The December 4, 2007 final rule made several changes to the proposal contained in the Notice of Proposed Rulemaking for that rule including removing the blue and green color boundary requirements from paragraph S14.4.1.3.2 and eliminating references to three additional SAE documents.

<sup>1</sup> 72 FR 68234, (Dec. 4, 2007). The agency published the Notice of Proposed Rulemaking proposing to reorganize the standard on December 30, 2005. 70 FR 77454, (Dec. 30, 2005).

SABIC Innovative Plastics US LLC (SABIC-IP) sent a letter to NHTSA on August 11, 2008, after the final rule comment period was over. In this letter, SABIC-IP stated that the agency did not allow for public comment when it made the decision to remove the blue and green color boundaries from the standard. SABIC-IP further stated that in removing the blue and green color boundaries from paragraph S14.4.1.3.2, the agency substantively changed the requirements of FMVSS No. 108 during the rewrite process. On July 13, 2011, NHTSA published a NPRM<sup>2</sup> initiating this rulemaking to replace the color boundaries that were removed during the administrative rewrite of the standard.

In the NPRM, the agency explained that while neither blue nor green are directly permitted by the standard, it is possible to use these color boundaries to certify a material to the outdoor exposure test. Once individually certified to the three year outdoor exposure test, the blue and clear material could be mixed to produce a clear material with a blue tint, which could then be used in a lamp lens provided the lamp itself emits light within the white color boundary. Under the standard, the mixed material can be certified to the outdoor exposure test without an additional three years of testing. The pre-rewrite version of the standard contained two tests for determining compliance with the color requirements in the standard, the Visual Method or the Tristimulus Method. The blue and green color boundary definitions that were removed are part of the color requirements of the Tristimulus method procedure. The NPRM proposed to amend FMVSS No. 108 to restore the color boundary definitions for green, restricted blue and signal blue so that the requirements of the rewrite coincide with those of the old standard.

## II. Public Comments on NPRM

NHTSA received four public comments in response to the Notice of Proposed Rulemaking for this rulemaking.<sup>3</sup> All of the comments supported reinstating the color boundary definitions for green, restricted blue and signal blue to FMVSS No. 108.

The Alliance of Automobile Manufacturers (the "Alliance") supported the rulemaking but stated that the agency omitted the color

requirements for green and blue when tested according to the visual method. The Alliance claimed that these requirements from SAE J578c *Color Specification for Electric Signal Lighting Devices*, (FEB 1977) (the third party standard from which the color boundaries were derived) were incorporated into the NPRM proposing the reorganization of the standard but were not incorporated into the December 4, 2007 Final Rule. The Alliance recommended that these requirements be reinstated into the standard as sections 14.4.1.3.2.4 and 14.4.1.3.2.5.

SABIC-IP submitted a comment urging the agency to restore the green and blue color boundaries to FMVSS No. 108. SABIC-IP also requested that the agency clarify that polymers and additives would not have to be retested to the three year outdoor exposure test after the effective date of the administrative rewrite before being combined to create new materials. SABIC-IP stated that the rewrite of the standard creates ambiguity as to whether combinations of individually certified materials can continue to be mixed to create new material and then certified to the outdoor exposure test without an additional three years of testing as was permitted under the pre-rewrite version of the standard. SABIC-IP requested that NHTSA amend paragraph S14.4.2.2.2 to state that materials and additives used in plastics could be changed without outdoor exposure testing if the materials had previously been tested to FMVSS No. 108 and found to meet the requirements. Paragraph S14.4.2.2.2 currently states that materials and additives used in plastics can be changed without outdoor exposure testing if the materials have previously been tested to "this section" and found to meet the requirements. SABIC-IP believes that it is possible to interpret the use of the words "this section" in paragraph S14.4.2.2.2 to require that materials be retested to the outdoor exposure test in the new paragraph S14.4.2.2.2, published in December 2007, before they can be used to create new materials. SABIC-IP stated that this interpretation would go against the stated goal of the rewrite of the standard to refrain from making any substantive change to the requirements.

SABIC-IP also asked the agency to clarify that the lower concentration of additive of previously tested materials used to create a new material according to S14.4.2.2.2 paragraph can be represented by a composition of zero.

## III. Agency Decision

Since it was not the agency's intention to create any substantive modifications to the standard, we have decided to amend FMVSS No. 108 to add the color boundary definitions for green, restricted blue and signal blue to the Tristimulus method procedure as proposed in the NPRM and to include the two missing color requirements from the visual method procedure so that the requirements of the rewrite coincide with those of the old standard.

We have decided not to amend paragraph S14.4.2.2.2 of FMVSS No. 108 as requested by SABIC-IP over the course of the rewrite rulemaking. We attempted, where ever possible, to avoid changes to the language of the standard. We note that the phrase "this section" refers to the requirements of paragraph S14.4.2.2 in general, not to a specific version of the standard. Thus, so long as the additives and polymers have previously been tested to and found to comply with the same substantive requirements as they appear in FMVSS No. 108, they can be added to create new materials without additional outdoor exposure testing. However, if the requirements of S14.4.2.2 were changed, previously tested additives and polymers would no longer have been tested to "this section" and would have to be retested to the outdoor exposure test before being used to create new materials under paragraph S14.4.2.2.2.

The agency will respond to SABIC-IP's comment about the lower concentration of additive used to create new materials being represented by a composition of zero in a letter of interpretation from the NHTSA Office of Chief Counsel.

## IV. Effective Date

The National Highway and Motor Vehicle Safety Act states that an FMVSS issued by NHTSA cannot become effective before 180 days after the standard is issued unless the agency makes a good cause finding that a different effective date is in the public interest. Additionally, the Administrative Procedure Act (5 U.S.C. 553(d)) requires that a rule be published 30 days prior to its effective date unless one of three exceptions applies. One of these exceptions is when the agency finds good cause for a shorter period. We have determined that it is in the public interest for this final rule to have an immediate effective date so that the effective date of this final rule coincides as closely as possible with the effective date of the 2007 rewrite of the standard. An effective date for this final rule that

<sup>2</sup> 76 FR 41181. (July 13, 2011).

<sup>3</sup> The Alliance of Automobile Manufacturers, SABIC-IP and two private individuals submitted comments in response to the NPRM.



closely coincides with the 2007 rewrite of the standard will ensure that the requirements of FMVSS No. 108 remain consistent so as to avoid unnecessary changes in the requirements of the standard that would force regulated parties to change their compliance strategies, potentially imposing costs on manufacturers while not improving safety.

## V. Regulatory Notices and Analyses

### A. Executive Order 12866, Executive Order 13563, and DOT Regulatory Policies and Procedures

NHTSA has considered the impact of this rulemaking action under Executive Order 12866, Executive Order 13563, and the DOT's regulatory policies and procedures. This final rule was not reviewed by the Office of Management and Budget (OMB) under E.O. 12866, "Regulatory Planning and Review." It is not considered to be significant under E.O. 12866 or the Department's regulatory policies and procedures.

This Final Rule restores existing requirements to the standard thereby maintaining flexibility in compliance for manufacturers who choose to use these colors to certify materials to the outdoor exposure test. Because this Final Rule merely restores existing requirements it is not expected to have any costs. The agency expects some minor unquantifiable benefits to manufacturers due to the continued availability of the green and blue color boundaries to certify to the outdoor exposure test. Because there are not any costs associated with this rulemaking and only minor unquantifiable benefits, we have not prepared a separate economic analysis for this rulemaking.

### B. Executive Order 13609: Promoting International Regulatory Cooperation

The policy statement in section 1 of Executive Order 13609 provides, in part:

The regulatory approaches taken by foreign governments may differ from those taken by U.S. regulatory agencies to address similar issues. In some cases, the differences between the regulatory approaches of U.S. agencies and those of their foreign counterparts might not be necessary and might impair the ability of American businesses to export and compete internationally. In meeting shared challenges involving health, safety, labor, security, environmental, and other issues, international regulatory cooperation can identify approaches that are at least as protective as those that are or would be adopted in the absence of such cooperation. International regulatory cooperation can also reduce, eliminate, or prevent unnecessary differences in regulatory requirements.

NHTSA is not aware of any conflicting regulatory approach taken by a foreign

government concerning the subject matter of this rulemaking.

### C. Regulatory Flexibility Act

In compliance with the Regulatory Flexibility Act, 5 U.S.C. 601 *et seq.*, NHTSA has evaluated the effects of this action on small entities. I hereby certify that this rule would not have a significant impact on a substantial number of small entities. The final rule would affect manufacturers of motor vehicle light equipment, but the entities that qualify as small businesses would not be significantly affected by this rulemaking because the agency is restoring requirements that previously existed in an older version of the regulation. This rulemaking is not expected to affect the cost of manufacturing motor vehicle lighting equipment.

### D. Executive Order 13132

NHTSA has examined today's rule pursuant to Executive Order 13132 (64 FR 43255, August 10, 1999) and concluded that no additional consultation with States, local governments or their representatives is mandated beyond the rulemaking process. The agency has concluded that the rulemaking would not have sufficient federalism implications to warrant consultation with State and local officials or the preparation of a federalism summary impact statement. The final rule would not have "substantial direct effects on the States, on the relationship between the national government and the States, or on the distribution of power and responsibilities among the various levels of government."

NHTSA rules can preempt in two ways. First, the National Traffic and Motor Vehicle Safety Act contains an express preemption provision: "When a motor vehicle safety standard is in effect under this chapter, a State or a political subdivision of a State may prescribe or continue in effect a standard applicable to the same aspect of performance of a motor vehicle or motor vehicle equipment only if the standard is identical to the standard prescribed under this chapter." 49 U.S.C. 30103(b)(1). It is this statutory command by Congress that preempts any non-identical State legislative and administrative law addressing the same aspect of performance.

The express preemption provision set forth above is subject to a savings clause under which "[c]ompliance with a motor vehicle safety standard prescribed under this chapter does not exempt a person from liability at common law." 49 U.S.C. 30103(e) Pursuant to this

provision, State common law tort causes of action against motor vehicle manufacturers that might otherwise be preempted by the express preemption provision are generally preserved. However, the Supreme Court has recognized the possibility, in some instances, of implied preemption of such State common law tort causes of action by virtue of NHTSA's rules, even if not expressly preempted. This second way that NHTSA rules can preempt is dependent upon there being an actual conflict between an FMVSS and the higher standard that would effectively be imposed on motor vehicle manufacturers if someone obtained a State common law tort judgment against the manufacturer, notwithstanding the manufacturer's compliance with the NHTSA standard. Because most NHTSA standards established by an FMVSS are minimum standards, a State common law tort cause of action that seeks to impose a higher standard on motor vehicle manufacturers will generally not be preempted. However, if and when such a conflict does exist—for example, when the standard at issue is both a minimum and a maximum standard—the State common law tort cause of action is impliedly preempted. See *Geier v. American Honda Motor Co.*, 529 U.S. 861 (2000).

Pursuant to Executive Order 13132 and 12988, NHTSA has considered whether this rule could or should preempt State common law causes of action. The agency's ability to announce its conclusion regarding the preemptive effect of one of its rules reduces the likelihood that preemption will be an issue in any subsequent tort litigation.

To this end, the agency has examined the nature (e.g., the language and structure of the regulatory text) and objectives of today's rule and finds that this rule, like many NHTSA rules, prescribes only a minimum safety standard. As such, NHTSA does not intend that this rule preempt state tort law that would effectively impose a higher standard on motor vehicle manufacturers than that established by today's rule. Establishment of a higher standard by means of State tort law would not conflict with the minimum standard announced here. Without any conflict, there could not be any implied preemption of a State common law tort cause of action.

### E. National Environmental Policy Act

NHTSA has analyzed this final rule for the purposes of the National Environmental Policy Act. The agency has determined that implementation of this action would not have any

significant impact on the quality of the human environment.

*F. Paperwork Reduction Act*

Under the procedures established by the Paperwork Reduction Act of 1995, a person is not required to respond to a collection of information by a Federal agency unless the collection displays a valid OMB control number. This final rule would not establish any new information collection requirements.

*G. National Technology Transfer and Advancement Act*

Under the National Technology Transfer and Advancement Act of 1995 (NTTAA) (Public Law 104-113), "all Federal agencies and departments shall use technical standards that are developed or adopted by voluntary consensus standards bodies, using such technical standards as a means to carry out policy objectives or activities determined by the agencies and departments." This Final Rule would not adopt or reference any new industry or consensus standards that were not already present in FMVSS No. 108.

*H. Civil Justice Reform*

With respect to the review of the promulgation of a new regulation, section 3(b) of Executive Order 12988, "Civil Justice Reform" (61 FR 4729, February 7, 1996) requires that Executive agencies make every reasonable effort to ensure that the regulation: (1) Clearly specifies the preemptive effect; (2) clearly specifies the effect on existing Federal law or regulation; (3) provides a clear legal standard for affected conduct, while promoting simplification and burden reduction; (4) clearly specifies the retroactive effect, if any; (5) adequately defines key terms; and (6) addresses other important issues affecting clarity and general draftsmanship under any guidelines issued by the Attorney General. This document is consistent with that requirement.

Pursuant to this Order, NHTSA notes as follows. The preemptive effect of this final rule is discussed above. NHTSA notes further that there is no requirement that individuals submit a petition for reconsideration or pursue other administrative proceeding before they may file suit in court.

*I. Unfunded Mandates Reform Act*

The Unfunded Mandates Reform Act of 1995 requires agencies to prepare a written assessment of the costs, benefits and other effects of proposed or final rules that include a Federal mandate likely to result in the expenditure by State, local or tribal governments, in the

aggregate, or by the private sector, of more than \$100 million annually (adjusted for inflation with base year of 1995). This final rule would not result in expenditures by State, local or tribal governments, in the aggregate, or by the private sector in excess of \$100 million annually.

*J. Executive Order 13211*

Executive Order 13211 (66 FR 28355, May 18, 2001) applies to any rulemaking that: (1) Is determined to be economically significant as defined under E.O. 12866, and is likely to have a significantly adverse effect on the supply of, distribution of, or use of energy; or (2) that is designated by the Administrator of the Office of Information and Regulatory Affairs as a significant energy action. This rulemaking is not subject to E.O. 13211.

*K. Regulation Identifier Number (RIN)*

The Department of Transportation assigns a regulation identifier number (RIN) to each regulatory action listed in the Unified Agenda of Federal Regulations. The Regulatory Information Service Center publishes the Unified Agenda in April and October of each year. You may use the RIN contained in the heading at the beginning of this document to find this action in the Unified Agenda.

*L. Privacy Act*

Anyone is able to search the electronic form of all comments received into any of our dockets by the name of the individual submitting the comment (or signing the comment, if submitted on behalf of an association, business, labor union, etc.). You may review DOT's complete Privacy Act Statement in the **Federal Register** published on April 11, 2000 (70 FR 19477-19478).

**List of Subjects in 49 CFR Part 571**

Imports, Motor vehicle safety, Motor vehicles, and Tires.

In consideration of the foregoing, NHTSA amends 49 CFR part 571 as set forth below.

**PART 571—FEDERAL MOTOR VEHICLE SAFETY STANDARDS**

■ 1. The authority citation for Part 571 continues to read as follows:

**Authority:** 49 U.S.C. 322, 30111, 30115, 30117 and 30166; delegation of authority at 49 CFR 1.50.

■ 2. Section 571.108 is amended by adding paragraphs S14.4.1.3.2.4, S14.4.1.3.2.5, S14.4.1.4.2.4, S14.4.1.4.2.5, and S14.4.1.4.2.6 to read as follows:

**§ 571.108 Standard No.108; Lamps, reflective devices, and associated equipment.**

\* \* \* \* \*

S14.4.1.3.2.4 Green. Green is not acceptable if it is less saturated (paler), yellower, or bluer than the limit standards.

S14.4.1.3.2.5 Blue. Blue is not acceptable if it is less saturated (paler), greener, or redder than the limit standards.

\* \* \* \* \*

S14.4.1.4.2.4 Green. The color of light emitted must fall within the following boundaries:

$y = 0.73 - 0.73x$  (yellow boundary)  
 $x = 0.63y - 0.04$  (white boundary)  
 $y = 0.50 - 0.50x$  (blue boundary)

S14.4.1.4.2.5 Restricted Blue. The color of light emitted must fall within the following boundaries:

$y = 0.07 + 0.81x$  (green boundary)  
 $x = 0.40 - y$  (white boundary)  
 $x = 0.13 + 0.60y$  (violet boundary)

S14.4.1.4.2.6 Signal Blue. The color of light emitted must fall within the following boundaries:

$y = 0.32$  (green boundary)  
 $x = 0.16$  (white boundary)  
 $x = 0.40 - y$  (white boundary)  
 $x = 0.13 + 0.60y$  (violet boundary)

\* \* \* \* \*

Issued on: November 28, 2012.

**David L. Strickland,**  
*Administrator.*

[FR Doc. 2012-29284 Filed 12-3-12; 8:45 am]

**BILLING CODE 4910-59-P**

**DEPARTMENT OF COMMERCE**

**National Oceanic and Atmospheric Administration**

**50 CFR Part 648**

[Docket No. 120321209-2643-02]

**RIN 0648-BC08**

**Fisheries of the Northeastern United States; Atlantic Mackerel, Squid, and Butterfish Fisheries; Framework Adjustment 5**

**AGENCY:** National Marine Fisheries Service (NMFS), National Oceanic and Atmospheric Administration (NOAA), Commerce.

**ACTION:** Final rule.

**SUMMARY:** NMFS is broadening the scope of individuals and entities approved to complete vessel fish hold capacity certifications for vessels issued Tier 1 and 2 limited access Atlantic mackerel permits under the Atlantic

**List of Subjects in 48 CFR Parts 2, 11, 23, and 52**

Government procurement.

Dated: July 6, 2011.

**Laura Auletta,**

*Acting Director, Office of Governmentwide Acquisition Policy, Office of Acquisition Policy.*

Therefore, DoD, GSA, and NASA propose amending 48 CFR parts 2, 11, 23, and 52 as set forth below:

1. The authority citation for 48 CFR parts 2, 11, 23, and 52 continues to read as follows:

**Authority:** 40 U.S.C. 121(c); 10 U.S.C. chapter 137; and 42 U.S.C. 2473(c).

**PART 2—DEFINITIONS OF WORDS AND TERMS****§ 2.101 [Amended]**

2. Amend section 2.101 by removing from paragraph (b)(2), in the definition “biobased product”, the words “(including plant, animal, and marine materials) or” and adding “and” in its place.

**PART 11—DESCRIBING AGENCY NEEDS**

3. Amend section 11.302 by revising paragraph (c)(2) to read as follows:

**§ 11.302 Policy.**

\* \* \* \* \*

(c) \* \* \*

(2) For biobased products, agencies may not require, as a condition of purchase of such products, the vendor or manufacturer to provide more data than would typically be provided by other business entities offering products for sale to the agency, other than data confirming the biobased content of a product (see 7 CFR 2902.8).

**PART 23—ENVIRONMENT, ENERGY AND WATER EFFICIENCY, RENEWABLE ENERGY TECHNOLOGIES, OCCUPATIONAL SAFETY, AND DRUG-FREE WORKPLACE****§ 23.404 [Amended]**

4. Amend section 23.404 by removing from paragraph (e)(1) the words “(including plant, animal, and marine materials)”.

5. Amend section 23.405 by revising paragraph (a)(2) and adding (a)(3) to read as follows:

**§ 23.405 Procedures.**

(a) \* \* \*

(2) *Biobased products.* Contracting officers should refer to USDA’s list of USDA-designated items (available through the Internet at [http://](http://www.biopreferred.gov)

[www.biopreferred.gov](http://www.biopreferred.gov)) and to their agencies’ affirmative procurement program when purchasing supplies that contain biobased material or when purchasing services that could include supplies that contain biobased material.

(3) When acquiring recovered material or biobased products, the contracting officer may request information or data on such products, including on the recycled or biobased content or related standards of the products (see 11.302(c)).

\* \* \* \* \*

**§ 23.406 [Amended]**

6. Amend section 23.406 by removing from paragraph (b) “<http://www.usda.gov/biopreferred>” and adding “<http://www.biopreferred.gov>” in its place.

**PART 52—SOLICITATION PROVISIONS AND CONTRACT CLAUSES**

7. Amend section 52.223–2 by—

a. Revising the date of the clause;

b. Removing from paragraph (b) “<http://www.usda.gov/biopreferred>” and adding <http://www.biopreferred.gov> in its place; and

c. Adding paragraphs (c) and (d) to read as follows:

**52.223–2 Affirmative Procurement of Biobased Products Under Service and Construction Contracts**

\* \* \* \* \*

Affirmative Procurement of Biobased Products Under Service and Construction Contracts (Date)

\* \* \* \* \*

(c) In the performance of this contract, the Contractor shall—

(1) Report to the cognizant Contracting Officer and the agency environmental manager on the product types and dollar value of any USDA-designated biobased products purchased by the Contractor during the previous year, between October 1 and September 30, in this contract;

(2) Submit this report no later than—

(i) October 31 of each year during contract performance; and

(ii) At the end of contract performance; and  
(iii) Contact the cognizant environmental manager to obtain the preferred submittal format, if that format is not specified in this contract.

(d) The cognizant environmental manager for this contract is: \_\_\_\_\_.

[Contracting Officer shall insert full name, phone number, and email address or Web site for reporting.]

[FR Doc. 2011–17453 Filed 7–12–11; 8:45 am]

**BILLING CODE 6820–EP–P**

**DEPARTMENT OF TRANSPORTATION****National Highway Traffic Safety Administration****49 CFR Part 571**

[Docket No. NHTSA–2011–0101]

RIN 2127–AK99

**Federal Motor Vehicle Safety Standards; Lamps, Reflective Devices, and Associated Equipment**

**AGENCY:** Department of Transportation (DOT), National Highway Traffic Safety Administration (NHTSA).

**ACTION:** Notice of proposed rulemaking (NPRM).

**SUMMARY:** NHTSA is proposing to restore the blue and green color boundaries to Federal Motor Vehicle Safety Standard (FMVSS) No. 108, *Lamps, Reflective Devices and Associated Equipment*, that were removed when the agency published a final rule reorganizing the standard on December 4, 2007.

**DATES:** Comments to this proposal must be received on or before September 12, 2011.

**ADDRESSES:** You may submit comments, identified by the docket number in the heading of this document, by any of the following methods:

- *Federal eRulemaking Portal:* Go to <http://www.regulations.gov>. Follow the instructions for submitting comments on the electronic docket site by clicking on “Help” or “FAQ.”

- *Mail:* Docket Management Facility, M–30, U.S. Department of Transportation, 1200 New Jersey Avenue, SE., West Building, Ground Floor, Room W12–140, Washington, DC 20590.

- *Hand Delivery:* U.S. Department of Transportation, 1200 New Jersey Avenue, SE., West Building, Ground Floor, Room W12–140, between 9 a.m. and 5 p.m. Eastern Time, Monday through Friday, except Federal holidays.

- *Fax:* 202–493–2251.

Regardless of how you submit comments, you should mention the docket number of this document.

You may call the Docket Management Facility at 202–366–9826.

*Instructions:* For detailed instructions on submitting comments and additional information on the rulemaking process, see the Public Participation heading of the Supplementary Information section of this document. Note that all comments received will be posted without change to <http://www.regulations.gov>, including any personal information provided.

*Privacy Act:* Anyone is able to search the electronic form of all comments received into any of our dockets by the name of the individual submitting the comment (or signing the comment, if submitted on behalf of an association, business, labor union, *etc.*). You may review DOT's complete Privacy Act Statement in the **Federal Register** published on April 11, 2000 (65 FR 19477–78) or you may visit <http://www.dot.gov/privacy.html>.

*Docket:* For access to the docket to read background documents or comments received, go to <http://www.regulations.gov>, or the street address listed above. Follow the online instructions for accessing the dockets.

**FOR FURTHER INFORMATION CONTACT:** For technical issues: Mr. Markus Price, Office of Crash Avoidance Standards, NHTSA, 1200 New Jersey Avenue, SE., West Building, Washington, DC 20590 (Telephone: (202) 366–0098) (Fax: (202) 366–7002).

*For legal issues:* Mr. Thomas Healy, Office of the Chief Counsel, NHTSA, 1200 New Jersey Avenue, SE., West Building, Washington, DC 20590 (Telephone: (202) 366–2992) (Fax: (202) 366–3820).

#### SUPPLEMENTARY INFORMATION:

### I. Background

NHTSA published a NPRM on December 30, 2005<sup>1</sup> to reorganize FMVSS No. 108 and improve the clarity of the standard's requirements thereby increasing its utility for regulated parties. It was the agency's goal during the rewrite process to make no substantive changes to the requirements of the standard.

FMVSS No. 108 has been in existence since 1968. The standard had been amended on an *ad hoc* basis over time resulting in a patchwork organization of the standard. Regulated parties had stated that the standard was difficult to interpret because of its organization. In response to these concerns the agency sought to rewrite the standard to make it more understandable by adopting a simplified numbering scheme, to improve organization by grouping related materials in a more logical and consistent sequence, and to reduce the certification burden of regulated parties who previously needed to review a few dozen third-party documents. The agency issued the December 30, 2005, NPRM in an attempt to address these concerns.

Based on the comments received in response to the NPRM, NHTSA published a final rule on December 4,

2007,<sup>2</sup> amending FMVSS No. 108 by reorganizing the regulatory text so that it provides a more straightforward and logical presentation of the applicable regulatory requirements; incorporating important agency interpretations of the existing requirements; and reducing reliance on third-party documents incorporated by reference. The preamble of the final rule again stated that the rewrite of FMVSS No. 108 was administrative in nature and would have no impact on the substantive requirements of the standard. The final rule made several changes to the proposal contained in the NPRM including removing the blue and green color boundary requirements from paragraph S14.4.1.3.2.

On August 11, 2008, SABIC Innovative Plastics sent a letter to NHTSA claiming that the agency did not allow for public comment when it made the decision to remove the blue and green color boundaries from the standard. SABIC further argued that in removing the blue and green color boundaries from paragraph S14.4.1.3.2, the agency substantively changed the requirements of FMVSS No. 108 during the rewrite process.

### II. Green and Blue Color Boundaries

Previous to the rewrite of the standard, paragraph S5.1.5 of FMVSS No. 108 required that the color of all lamps required by the standard comply with SAE J578c, *Color Specification for Electric Signal Lighting Devices*, (FEB 1977). SAE J578c contained color boundary definitions for red, yellow, white, green, restricted blue, and signal blue light. The NPRM included the boundary definition for the colors blue and green, but left out restricted blue. In the final rule the agency removed the color boundary definitions for green and blue from paragraph S14.4.1.3.2, retaining only the definitions for the red, yellow, and white color boundaries.

The agency is aware that, although neither blue nor green are directly used within the standard, it is possible to use these color boundaries to certify a material to the outdoor exposure test located in the paragraphs of S14.4.2.2. Prior to the reorganization final rule, a manufacturer could separately certify both a clear (white) material and a blue material to the haze test. The blue material alone could not be used in a lamp because the lamp itself would not emit the color of light required by the standard (only white, amber, and red lights are permitted). Once individually certified to the three year haze test, however, the blue and clear material

could be mixed to produce a clear material with a blue tint, which could then be used in a lamp lens provided the lamp itself emits light within the white color boundary. Under the standard, the mixed material can be certified to the haze test without an additional three years of testing.

The agency recognizes that removing the color definitions for blue and green creates a substantive change to the requirements of FMVSS No. 108. Since it was not the agency's intention to create any substantive modifications to the standard, as stated in the NPRM and preamble of the final rule, the agency is proposing to amend FMVSS No. 108 to add color boundary definitions for green, restricted blue and signal blue so that the requirements of the rewrite coincide with those of the old standard. Further, the agency notes that these additional color boundary definitions have no impact on color that any lamp must emit. The agency is not proposing to change the color requirements for any lamp mandated by FMVSS No. 108.

### III. Costs, Benefits, and the Proposed Compliance Date

Because this proposal only restores an existing requirement to the standard, the agency does not anticipate that there would be any costs or benefits associated with this rulemaking action. Accordingly, the agency did not conduct a separate economic analysis for this rulemaking.

The agency proposes an effective date of December 1, 2012, should a final rule be issued, to coincide with the effective date of the FMVSS No. 108 administrative rewrite.

### IV. Public Participation

*How do I prepare and submit comments?*

Your comments must be written and in English. To ensure that your comments are correctly filed in the Docket, please include the docket number of this document in your comments. Your comments must not be more than 15 pages long.<sup>3</sup> We established this limit to encourage you to write your primary comments in a concise fashion. However, you may attach necessary additional documents to your comments. There is no limit on the length of the attachments.

Please submit your comments by any of the following methods:

- *Federal eRulemaking Portal:* go to <http://www.regulations.gov>. Follow the instructions for submitting comments on the electronic docket site by clicking on "Help" or "FAQ."

<sup>1</sup> 70 FR 77454, (Dec. 30, 2005).

<sup>2</sup> 72 FR 68234, (Dec. 4, 2007).

<sup>3</sup> See 49 CFR 553.21.

- *Mail:* Docket Management Facility, M-30, U.S. Department of Transportation, West Building, Ground Floor, Rm. W12-140, 1200 New Jersey Avenue, SE., Washington, DC 20590.

- *Hand Delivery or Courier:* West Building Ground Floor, Room W12-140, 1200 New Jersey Avenue, SE., between 9 a.m. and 5 p.m. Eastern Time, Monday through Friday, except Federal holidays.

- *Fax:* (202) 493-2251.

If you are submitting comments electronically as a PDF (Adobe) file, we ask that the documents submitted be scanned using an Optical Character Recognition (OCR) process, thus allowing the agency to search and copy certain portions of your submissions.<sup>4</sup>

Please note that pursuant to the Data Quality Act, in order for substantive data to be relied upon and used by the agency, it must meet the information quality standards set forth in the Office of Management and Budget (OMB) and DOT Data Quality Act guidelines. Accordingly, we encourage you to consult the guidelines in preparing your comments. OMB's guidelines may be accessed at <http://www.whitehouse.gov/omb/fedreg/reproducible.html>. DOT's guidelines may be accessed at <http://dmses.dot.gov/submit/DataQualityGuidelines.pdf>.

*How can I be sure that my comments were received?*

If you submit your comments by mail and wish Docket Management to notify you upon its receipt of your comments, enclose a self-addressed, stamped postcard in the envelope containing your comments. Upon receiving your comments, Docket Management will return the postcard by mail.

*How do I submit confidential business information?*

If you wish to submit any information under a claim of confidentiality, you should submit three copies of your complete submission, including the information you claim to be confidential business information, to the Chief Counsel, NHTSA, at the address given above under **FOR FURTHER INFORMATION CONTACT**. When you send a comment containing information claimed to be confidential business information, you should include a cover letter setting forth the information specified in our confidential business information regulation.<sup>5</sup>

In addition, you should submit a copy, from which you have deleted the

claimed confidential business information, to the Docket by one of the methods set forth above.

*Will the agency consider late comments?*

We will consider all comments received before the close of business on the comment closing date indicated above under **DATES**. To the extent possible, we will also consider comments received after that date. Therefore, if interested persons believe that any new information the agency places in the docket affects their comments, they may submit comments after the closing date concerning how the agency should consider that information for the final rule.

If a comment is received too late for us to consider in developing a final rule (assuming that one is issued), we will consider that comment as an informal suggestion for future rulemaking action.

*How can I read the comments submitted by other people?*

You may read the materials placed in the docket for this document (e.g., the comments submitted in response to this document by other interested persons) at any time by going to <http://www.regulations.gov>. Follow the online instructions for accessing the dockets. You may also read the materials at the Docket Management Facility by going to the street address given above under **ADDRESSES**. The Docket Management Facility is open between 9 a.m. and 5 p.m. Eastern Time, Monday through Friday, except Federal holidays.

## V. Regulatory Notices and Analyses

A. Executive Order 12866, Executive Order 13563, and DOT Regulatory Policies and Procedures

NHTSA has considered the impact of this rulemaking action under Executive Order 12866, Executive Order 13563, and the Department of Transportation's regulatory policies and procedures. This rulemaking document was not reviewed by the Office of Management and Budget under E.O. 12866, "Regulatory Planning and Review." It is not considered to be significant under E.O. 12866 or the Department's regulatory policies and procedures.

B. National Environmental Policy Act

We have reviewed this proposal for the purposes of the National Environmental Policy Act and determined that it would not have a significant impact on the quality of the human environment.

C. Regulatory Flexibility Act

Pursuant to the Regulatory Flexibility Act (5 U.S.C. 601 *et seq.*, as amended by the Small Business Regulatory Enforcement Fairness Act (SBREFA) of 1996), whenever an agency is required to publish a notice of rulemaking for any proposed or final rule, it must prepare and make available for public comment a regulatory flexibility analysis that describes the effect of the rule on small entities (*i.e.*, small businesses, small organizations, and small governmental jurisdictions). The Small Business Administration's regulations at 13 CFR part 121 define a small business, in part, as a business entity "which operates primarily within the United States." 13 CFR 121.105(a). No regulatory flexibility analysis is required if the head of an agency certifies the rule will not have a significant economic impact on a substantial number of small entities.

NHTSA has considered the effects of the proposed rule under the Regulatory Flexibility Act. I certify that this proposed rule would not have a significant economic impact on a substantial number of small entities. This proposal restores the green and blue color boundaries contained in the currently applicable version of FMVSS No. 108 to the administrative rewrite of FMVSS No. 108 which has not yet taken effect. Accordingly, we do not anticipate that this proposal would have a significant economic impact on a substantial number of small entities.

D. Executive Order 13132 (Federalism)

NHTSA has examined today's final rule pursuant to Executive Order 13132 (64 FR 43255, August 10, 1999) and concluded that no additional consultation with States, local governments or their representatives is mandated beyond the rulemaking process. The agency has concluded that the rulemaking would not have sufficient federalism implications to warrant consultation with State and local officials or the preparation of a federalism summary impact statement. The final rule would not have "substantial direct effects on the States, on the relationship between the national government and the States, or on the distribution of power and responsibilities among the various levels of government."

E. Executive Order 12988 (Civil Justice Reform)

Pursuant to Executive Order 12988, "Civil Justice Reform,"<sup>6</sup> NHTSA has

<sup>4</sup> Optical character recognition (OCR) is the process of converting an image of text, such as a scanned paper document or electronic fax file, into computer-editable text.

<sup>5</sup> See 49 CFR part 512.

<sup>6</sup> 61 FR 4729 (Feb. 7, 1996).

considered whether this rulemaking would have any retroactive effect. This proposed rule does not have any retroactive effect.

#### F. Unfunded Mandates Reform Act

Section 202 of the Unfunded Mandates Reform Act of 1995 (UMRA) requires Federal agencies to prepare a written assessment of the costs, benefits, and other effects of a proposed or final rule that includes a Federal mandate likely to result in the expenditure by State, local, or tribal governments, in the aggregate, or by the private sector, of more than \$100 million in any one year (adjusted for inflation with base year of 1995).

Before promulgating a rule for which a written statement is needed, section 205 of the UMRA generally requires NHTSA to identify and consider a reasonable number of regulatory alternatives and adopt the least costly, most cost-effective, or least burdensome alternative that achieves the objectives of the rule. The provisions of section 205 do not apply when they are inconsistent with applicable law. Moreover, section 205 allows NHTSA to adopt an alternative other than the least costly, most cost-effective, or least burdensome alternative if the agency publishes with the final rule an explanation why that alternative was not adopted.

This proposed rule is not anticipated to result in the expenditure by state, local, or tribal governments, in the aggregate, or by the private sector in excess of \$100 million annually. The cost impact of this proposed rule is expected to be \$0. Therefore, the agency has not prepared an economic assessment pursuant to the Unfunded Mandate Reform Act.

#### G. Paperwork Reduction Act

Under the procedures established by the Paperwork Reduction Act of 1995 (PRA), a person is not required to respond to a collection of information by a Federal agency unless the collection displays a valid OMB control number. This proposed rule does not contain any collection of information requirements requiring review under the PRA.

#### H. Executive Order 13045

Executive Order 13045<sup>7</sup> applies to any rule that: (1) Is determined to be economically significant as defined under E.O. 12866, and (2) concerns an environmental, health or safety risk that NHTSA has reason to believe may have a disproportionate effect on children. If

the regulatory action meets both criteria, we must evaluate the environmental health or safety effects of the proposed rule on children, and explain why the proposed regulation is preferable to other potentially effective and reasonably feasible alternatives considered by us.

This proposed rule does not pose such a risk for children. The primary effects of this proposal are to amend the lighting standard to restore the green and blue color boundaries.

#### I. National Technology Transfer and Advancement Act

Section 12(d) of the National Technology Transfer and Advancement Act (NTTAA) requires NHTSA to evaluate and use existing voluntary consensus standards in its regulatory activities unless doing so would be inconsistent with applicable law (e.g., the statutory provisions regarding NHTSA's vehicle safety authority) or otherwise impractical.

Voluntary consensus standards are technical standards developed or adopted by voluntary consensus standards bodies. Technical standards are defined by the NTTAA as "performance-based or design-specific technical specification and related management systems practices." They pertain to "products and processes, such as size, strength, or technical performance of a product, process or material."

Examples of organizations generally regarded as voluntary consensus standards bodies include the American Society for Testing and Materials (ASTM), the Society of Automotive Engineers (SAE), and the American National Standards Institute (ANSI). If NHTSA does not use available and potentially applicable voluntary consensus standards, we are required by the Act to provide Congress, through OMB, an explanation of the reasons for not using such standards.

This proposal would not adopt or reference any new industry or consensus standards that were not already present in FMVSS No. 108.

#### J. Executive Order 13211

Executive Order 13211<sup>8</sup> applies to any rule that: (1) Is determined to be economically significant as defined under E.O. 12866, and is likely to have a significant adverse effect on the supply, distribution, or use of energy; or (2) that is designated by the Administrator of the Office of Information and Regulatory Affairs as a significant energy action. If the

regulatory action meets either criterion, we must evaluate the adverse energy effects of the proposed rule and explain why the proposed regulation is preferable to other potentially effective and reasonably feasible alternatives considered by NHTSA.

This proposal restores the green and blue color boundaries contained in the currently applicable version of FMVSS No. 108 to the administrative rewrite of FMVSS No. 108 which has not yet taken effect. Therefore, this proposed rule will not have any adverse energy effects. Accordingly, this proposed rulemaking action is not designated as a significant energy action.

#### K. Regulation Identifier Number (RIN)

The Department of Transportation assigns a regulation identifier number (RIN) to each regulatory action listed in the Unified Agenda of Federal Regulations. The Regulatory Information Service Center publishes the Unified Agenda in April and October of each year. You may use the RIN contained in the heading at the beginning of this document to find this action in the Unified Agenda.

#### L. Plain Language

Executive Order 12866 requires each agency to write all rules in plain language. Application of the principles of plain language includes consideration of the following questions:

- Have we organized the material to suit the public's needs?
- Are the requirements in the rule clearly stated?
- Does the rule contain technical language or jargon that isn't clear?
- Would a different format (grouping and order of sections, use of headings, paragraphing) make the rule easier to understand?
- Would more (but shorter) sections be better?
- Could we improve clarity by adding tables, lists, or diagrams?
- What else could we do to make the rule easier to understand?

If you have any responses to these questions, please include them in your comments on this proposal.

#### M. Privacy Act

Anyone is able to search the electronic form of all comments received into any of our dockets by the name of the individual submitting the comment (or signing the comment, if submitted on behalf of an organization, business, labor union, etc.). You may review DOT's complete Privacy Act statement in the **Federal Register** published on April 11, 2000 (Volume 65, Number 70; Pages 19477–78) or you

<sup>7</sup> 62 FR 19885 (Apr. 23, 1997).

<sup>8</sup> 66 FR 28355 (May 18, 2001).

may visit <http://www.dot.gov/privacy.html>.

In consideration of the foregoing, NHTSA proposes to amend 49 CFR part 571 as set forth below.

**PART 571—FEDERAL MOTOR VEHICLE SAFETY STANDARDS**

1. The authority citation for part 571 continues to read as follows:

**Authority:** 49 U.S.C. 322, 30111, 30115, 30117, 30166; delegation of authority at 49 CFR 1.50.

**§ 571.108 [Amended]**

Section 571.108 is amended effective December 1, 2012 by adding paragraphs S14.4.1.4.2.4, S14.1.4.2.5, and S14.4.1.4.2.6 to read as follows:

\* \* \* \* \*

S14.4.1.4.2.4 Green. The color of light emitted must fall within the following boundaries:

$y = 0.73 - 0.73x$  (yellow boundary);

$y = 0.50 - 0.50x$  (blue boundary);

$x = 0.63y - 0.04$  (white boundary).

S14.4.1.4.2.5 Restricted Blue. The color of light emitted must fall within the following boundaries:

$y = 0.07 + 0.81x$  (green boundary);

$x = 0.40 - y$  (white boundary);

$x = 0.13 + 0.60y$  (violet boundary).

S14.4.1.4.2.6 Signal Blue. The color of light emitted must fall within the following boundaries:

$y = 0.32$  (green boundary);

$x = 0.40 - y$  (white boundary);

$x = 0.16$  (white boundary);

$x = 0.13 + 0.60y$  (violet boundary).

\* \* \* \* \*

Issued on: July 7, 2011.

**Christopher J. Bonanti,**

*Associate Administrator for Rulemaking.*

[FR Doc. 2011-17658 Filed 7-12-11; 8:45 am]

**BILLING CODE 4910-59-P**



October 22, 2013

The Honorable David L. Strickland  
Administrator  
National Highway Traffic Safety Administration  
1200 New Jersey Avenue S.E., West Building  
Washington D.C. 20590-0001

RE: Notice of update of SAE J576 to include specification for Diffusion Polymers for automotive lighting applications

Dear Administrator Strickland:

**The purpose of this letter is to provide notification of an update to SAE J576-*Plastic Material or Materials for Use in Optical Parts Such as Lenses and Reflex Reflectors of Motor Vehicle Lighting Devices*, effective February 2010. This updated version of J576 includes a method to evaluate “degradation in performance caused by weathering exposure of diffusion material(s) that cannot be measured by current test methods.”**

The changes in SAE J576 (FEB 2010) provide for the use of controlled light scattering plastic materials, herein referred to as Diffusing Plastic Materials. Diffusing Plastic Materials intentionally scatter transmitted light to specific intended levels as defined in SAE J576 (FEB 2010) as having an initial unexposed haze value greater than 30% when measured in accordance with ASTM D1003. The ASTM D1003 scope does not allow for materials with measured values greater than 30%. Diffusing Plastic Materials cannot be evaluated for durability using the conventional "increase of haze" methodology since measurement of haze of Diffusing Plastic Materials is not within the scope of ASTM D1003. This new evaluation methodology is limited to Diffusing Plastic Materials only and requires a more stringent maintenance of luminous transmittance. All other existing exposure, testing and requirements remain unchanged for all materials. No other changes have been made or allowed in the February 2010 revision for transparent plastic materials. Definitions have been incorporated as necessary to define this Diffusing Plastic Materials.



SAE and the SAE Lighting Systems Group believe that this revised document strives to maintain the relevance of standards within the context of changing technologies in the automotive lighting field that could not be anticipated or addressed at the time of the publication of the existing text (SAE J576 JUL91). SAE and the SAE Lighting Systems Group further believe that if and when NHTSA amends the current FMVSS lighting standard, referencing SAE J576 (FEB 2010) would benefit the safety of the public as well as that of the automotive industry.

Sincerely,

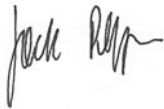
A handwritten signature in black ink, appearing to read "Jack Pokrzywa". The signature is fluid and cursive, with a long horizontal stroke at the end.

Jack Pokrzywa  
Business Unit Leader  
Global Ground Vehicle Standards

cc: Mr. Timothy P. Mellon, Director, Government Affairs, SAE International  
Mr. Bart P. Terburg, Chairman, SAE Lighting Systems Group



U.S. Department  
of Transportation

**National Highway  
Traffic Safety  
Administration**

NOV 6 2009

1200 New Jersey Avenue SE,  
Washington, DC 20590

Mr. Jim Wilson  
Marketing Director, Lighting  
Sabic Innovative Plastics  
Two Towne Square  
Southfield, MI 48076

Dear Mr. Wilson:

This responds to your letter regarding requirements for inner lenses in Federal Motor Vehicle Safety Standard (FMVSS) No. 108, Lamps, Reflective Devices, and Associated Equipment. Specifically, you asked whether inner lenses are subject to certain performance requirements of the version of FMVSS No. 108 that are scheduled to take effect on December 1, 2009. The answer is that inner lenses are required to meet the haze test requirements, similar to the way they are in the currently applicable version of FMVSS No. 108.

By way of background, the National Highway Traffic Safety Administration (NHTSA) is authorized by the National Traffic and Motor Vehicle Safety Act (Safety Act) to issue FMVSSs that set performance requirements for new motor vehicles and new items of motor vehicle equipment (see 49 U.S.C. Chapter 301). NHTSA does not provide approvals of motor vehicles or motor vehicle equipment. Instead, manufacturers are required to self-certify that their products conform to all applicable safety standards that are in effect on the date of manufacture. NHTSA selects a sampling of new vehicles and equipment each year to determine their compliance with applicable FMVSSs. If our testing or examination reveals an apparent noncompliance, we may require the manufacturer to remedy the noncompliance, and may initiate an enforcement proceeding if necessary to ensure that the manufacturer takes appropriate action.

In your letter, you state you seek confirmation that FMVSS No. 108 does not require plastic materials used for inner lenses to meet the performance requirements in S14.4.2.2.4 when they are covered by outer material meeting the requirements of that section and not exposed directly to sunlight. Neither the currently applicable version of FMVSS No. 108, nor the version of the standard that becomes effective on December 1, 2009 (hereinafter, "the rewrite)," supports that position.



For reference, paragraph S5.1.2 of FMVSS No. 108 reads as follows:

S5.1.2 Plastic materials used for optical parts such as lenses and reflectors shall conform to SAE Recommended Practice J576 JUL91, except that:  
(a) Plastic lenses (other than those incorporating reflex reflectors) used for inner lenses or those covered by another material and not exposed directly to sunlight *shall meet the requirements* of paragraphs 3.3 and 4.2 of SAE J576 JUL91 *when covered by the outer lens or other material*; [emphasis added]<sup>1</sup> . . . .

We interpret this requirement as follows. The requirement in S5.1.2 which states that plastic materials shall conform to SAE J576 JUL91 is the general requirement. The subparagraphs ((a) through (g)), are exceptions to this requirement. Therefore, the exception described in subparagraph (a) requires plastic lenses used for inner lenses to meet the specifications of paragraphs 3.3 and 4.2 of SAE J576 JUL91 *while covered by the outer lens*. This is instead of being required to meet these specifications while directly exposed to sunlight.<sup>2</sup> The inner lenses are not, as you suggest, fully excluded from the general test requirements in S5.1.2.

We believe that the relevant paragraph S14.4.2.2.4 in the rewrite is substantively identical. For reference, that paragraph reads as follows:

S14.4.2.2.4 *Performance requirements.* Plastic lenses, other than those incorporating reflex reflectors, used for inner lenses or those covered by another material and not exposed directly to sunlight must meet the optical material test requirements when covered by the outer lens or other material.

We interpret this paragraph to establish the same requirements as paragraph S5.1.2 and S5.1.2(a) in the current standard. With regard to plastic used for inner lenses, and not exposed directly to sunlight, they must “meet the optical material test requirements” when covered by the outer lens. This is the same as is currently required by FMVSS No. 108.

You also provide an analysis as to why you believe that inner lenses are not required to be certified to the specifications of S5.1.2. We respond to that analysis below.

In your letter, you state that in a 1970 final rule (35 FR 16840, October 31, 1970), NHTSA “made clear that inner lenses would be considered to be protected when covered by an outer lens and not directly exposed to sunlight.” We have reviewed the final rule at

---

<sup>1</sup> For reference, paragraphs 3.3 and 4.2 of SAE Recommended Practice J576, “Plastic Materials for Use in Optical Parts such as Lenses and Reflex Reflectors of Motor Vehicle Lighting Devices,” revised July 1991, relate to the “Outdoor Exposure Tests” and the “After Outdoor Exposure” requirements, respectively. SAE J576 has been incorporated by reference into FMVSS No. 108.

<sup>2</sup> The language in paragraph 3.3 of SAE J576 JUL91 does not specify that protected inner lenses can be covered by the outer lens during the outdoor exposure tests. It specifies a shorter, but otherwise similar, outdoor exposure test than the one for exposed outer lenses.

issue and have not found a relevant difference between that version and the current version. It too states that “[p]lastic materials used as inner lenses... and not exposed directly to sunlight shall meet the requirements of paragraphs 3.4 and 4.2 of SAE J576b when covered by the outer lens or other material.”<sup>3</sup>

Finally, we note you argued that “the fact that inner lenses are ‘protected’ is critical when applying the SAE Recommended Practice upon which the standard is based.” We agree that the lenses you describe in this letter would be considered “protected.” However, merely because a lens is protected does not mean it is not subject to a weathering test. Instead, according to the SAE Recommended Practice referenced in FMVSS No. 108 (SAE J576 JUL91), protected lenses are subject to test requirements – albeit less stringent requirements than “exposed” lenses (a 6-month weathering period, instead of 3 years).

If you have any further questions, please contact Ari Scott of my staff at (202) 366-2992.

Sincerely,



O. Kevin Vincent  
Chief Counsel

---

<sup>3</sup> 70 FR 16843.

Helping You Put Your Products To The Test



THE GLOBAL LEADER IN  
PRODUCT DURABILITY, PERFORMANCE &  
WEATHERING TESTING INSTRUMENTS & SERVICES

# Instruments

## Accelerated Weathering ❖ Corrosion ❖ Flammability ❖ Solar Environmental ❖ Technical Lighting

### Ci Series Weather-Ometers



Atlas' flagship accelerated weathering instruments offer superior performance, innovative features, and large capacity.

- ◆ Water-cooled xenon arc lamps and advanced filter technology deliver the best simulation of natural sunlight
- ◆ Best-in-class uniformity for irradiance, temperature, relative humidity and spray
- ◆ Intuitive touch screen controls
- ◆ Custom testing capabilities

### SUNTEST® Family



The most widely used flatbed xenon test chambers available in tabletop or free standing models to meet lower testing capacity needs. Features include:

- ◆ Optical light filters to simulate indoor/outdoor sunlight
- ◆ A variety of accessories ideal for testing realistic end-use conditions
- ◆ Best-in-class flatbed irradiance and temperature uniformity

### Xenotest® Instruments



These premium air-cooled accelerated weathering instruments offer an array of options to meet virtually all global weathering and lightfastness testing requirements.

- ◆ Designed with state-of-the-art controls
- ◆ On-rack radio-controlled sensor technology for superior monitoring of light and temperature
- ◆ High water and power efficiency

### UVTest



An economical fluorescent/UV weathering test instrument for product screening at lower operating costs.

- ◆ Simple touch screen operation and control in several languages
- ◆ Patented irradiance calibration safety access ports
- ◆ Remote Ethernet data acquisition application
- ◆ Recirculating spray water option

### Corrosion Cabinets



The most sophisticated and versatile corrosion and salt fog cabinets available. Capable of replicating automatic cycling between several environmental conditions to reduce the need to move or otherwise handle test specimens.

- ◆ Design maximizes testing volume
- ◆ Large solution reservoir
- ◆ Optional features allow for simulation of several environmental conditions

### Flammability Chambers



Atlas flammability chambers offer unmatched accuracy, repeatability and safety when determining the burn rates and resistance of various materials.

- ◆ All chambers are easy to install and operate
- ◆ Specimen holders available to accommodate a variety of material types
- ◆ Chambers are available for appliance, aircraft and automotive applications

### Solar Simulation Systems



Atlas Custom Systems designs and builds custom solar simulation systems such as walk-in chambers or full-scale test facilities. These full scale test facilities use a series of highly coordinated metal halide lights to provide uniform radiant energy to meet the demanding testing needs of many industries.

### Solar Environmental Chambers



A group of integrated, easy-to-use test chambers for various solar and environmental applications. These instruments combine environmental simulation with metal halide lighting technology and are ideal for testing medium to large sized automotive, plastics, electronics and 3D components, finished products as well as PV modules.

### Technical Lighting Systems



Atlas/KHS technical lighting systems are designed for high-speed photography and video. These systems are ideal for crash testing and other safety experiments, custom designed to match the complex illumination requirements of various test configurations. Available with conventional HMI light sources or the latest LED technology, these lighting systems offer an array of solutions for analytical testing of high speed events.

**Our mission is to help our customers worldwide provide the most reliable and durable product solutions through our combined experience and expertise in weathering instruments and testing, custom capabilities, consulting and global support.**

## Services

### Natural & Accelerated Weathering Testing ❖ Evaluations ❖ Consulting ❖ Technical Support ❖ Client Education

#### Natural Weathering Services



Atlas offers outdoor weathering sites worldwide to ensure factors from a variety of climates can be tested.

- ◆ Static Exposure Testing
- ◆ Sun Tracking Exposure Testing
- ◆ EMMAQUA® Accelerated Outdoor Testing
- ◆ Ultra-Accelerated Weathering Testing
- ◆ Automotive Exposure Testing (Samples, Components, Complete Vehicles)

#### Accelerated Laboratory Weathering Services



Atlas Weathering Services Group operates one of the largest networks of ISO/IEC 17025 accredited accelerated weathering testing laboratories in the world. Our indoor exposure labs offer artificial accelerated weathering tests and a variety of other environmental test programs, all designed to accurately simulate true end-use conditions and meet global weathering standards.

#### Evaluation Services



Atlas offers a wide range of evaluation and measurement services for your specimens during and after the weathering process.

- ◆ Instrumental Color/Gloss Measurements
- ◆ Visual Evaluations
- ◆ Photography/IR Imaging
- ◆ Emittance
- ◆ Spectral Transmittance/Reflectance
- ◆ Solar Reflectance Index
- ◆ Additional Optical Property Measurements

#### Consulting Solutions



Atlas Consulting Solutions offers design and implementation of environmental durability testing methods, programs, and strategies. Our international group of weathering experts help you achieve your objectives through all stages of the value chain from materials to components, systems to end-use products.

#### Worldwide Technical Support



Proper maintenance is critical in order for your instrument to operate at peak performance. Atlas' AMECARE Performance Services Program ensures that your instrument will operate optimally at all times. Benefits include:

- ◆ Preventative maintenance inspections
- ◆ Scheduled ISO accredited calibrations (where available)
- ◆ Detailed service reports with professional assessment of key components

#### Client Education & Training



Atlas offers an array of resources designed to advance your weathering education and provide you with the knowledge you need to successfully meet your testing requirements. Events include:

- ◆ Seminars
- ◆ Workshops
- ◆ Webcasts
- ◆ In-House Programs
- ◆ Technical Conferences

#### Solar Industry Solutions



Atlas offers a complete portfolio of testing services to evaluate the performance, durability and reliability of solar cells, modules, complete arrays, concentrated solar power products and solar thermal collectors. Atlas also offers its proprietary Atlas 25® long-term durability testing program for solar modules.

# Ultra-Accelerated EMMA<sup>®</sup>





# THE BENEFITS OF ULTRA-ACCELERATED TESTING

## What is the Ultra-Accelerated EMMA®?

The Ultra-Accelerated EMMA (UA-EMMA) is Atlas' latest advancement in natural exposure testing. This new outdoor testing device delivers approximately 10-12 years of equivalent radiation exposure as would be received in a standard outdoor testing rack in South Florida in a single year.

The system achieves this accelerated exposure through a patented "cool mirror" technology that has very high reflectance in the UV and near visible wavelength ranges while attenuating reflectance in the longer wavelength visible and IR portions of the solar spectrum.



## What are the Advantages?

The new UA-EMMA system allows for greatly accelerated testing while fulfilling three critical testing requirements:

- Exposes many different types of materials to ultra-high UV irradiance
- Maintains high fidelity to the natural solar UV spectrum
- Keeps specimens at acceptable exposure temperatures

Black Panel Temperature Performance  
UA-EMMA vs. Standard EMMA Data

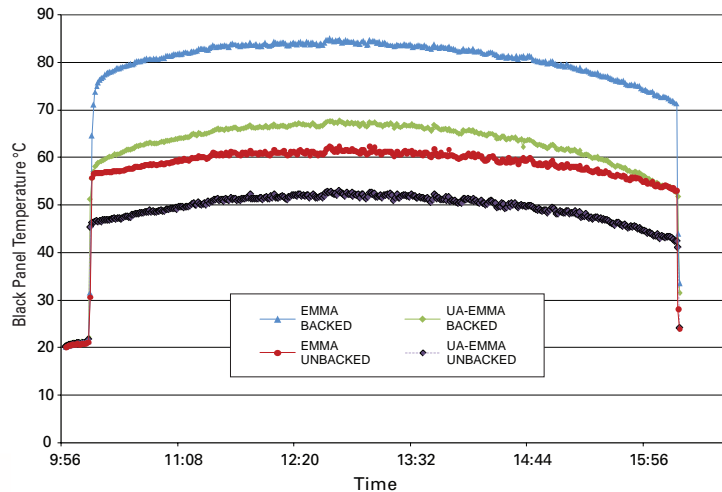

Comparison of Polystyrene (PS) Reference Material in Standard EMMA and UA-EMMA by UV Radiant Exposure

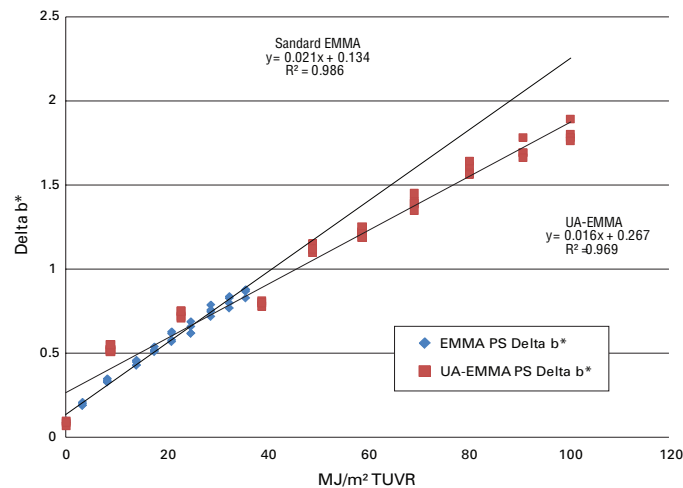

## Ideal Materials for UA-EMMA® Testing

- Materials that require a long service life
- Transparent and glazed materials
- Temperature sensitive materials such as PVC
- Coatings applied to metal panels
- Materials that perform well in EMMA or EMMAQUA exposure testing

## Applications

- Adhesives
- Agricultural Films
- Automotive Exteriors
- Building Materials
- Elastomers
- Glass (Architectural & Automotive)
- Packaging
- Paints & Coatings
- Plastics
- Roofing
- Sealants

## EMMAQUA® Weathering Standards

The table below lists selected standards for EMMAQUA exposure. For details, refer to the individual standards. Test methods which are proprietary to individual companies and which also specify Fresnel-based exposure methods are not listed here.

EMMAQUA STANDARD	SCOPE	COUNTRY
ISO 877-3	Plastics	International
ASTM D3841	Glass-fiber reinforced polyester	USA
ASTM D4141	Coatings	USA
ASTM D4364	Plastics	USA
ASTM D5722	Coated hardboard	USA
ASTM E1596	PV modules	USA
ASTM G90	Non-metallic materials	USA
SAE J576	Optical automotive plastics	USA
SAE J1961	Automotive exterior	USA
SAE-AMS-T-22085	Preservation sealing tape	USA
JIS Z2381	General	Japan



1958

Atlas' DSET Laboratories relocates from Phoenix to New River, Arizona. The EMMAQUA device is redesigned with a steel framework and more efficient spray delivery system.



1969

The first EMMAQUA® device, constructed with a wooden frame and sheet metal skin, is patented, manufactured and placed into service.



1986

EMMAQUA+, the next generation of accelerated weathering devices, is introduced. Advancements include individual cycle programming, black panel temperature control, and altazimuth solar tracking for more efficient delivery of full-spectrum solar energy.

The MQ3K is launched, utilizing state-of-the-art technology in computer-controlled cycle programming, more accurate altazimuth solar tracking, one-touch start/stop, error sensing feedback and the most-specular mirrors available.



1999



2004

Atlas introduces the UA-EMMA, the latest advancement in outdoor accelerated testing. This device couples the EMMA platform with a new patented mirror system, optimizing real-world correlation.

Atlas introduces four patented suites of Temperature-Controlled EMMAQUA. (Static, Night, Dynamic Temperature and Variable Irradiance Control). This breakthrough allows for the testing of materials that are sensitive to thermal buildup.

2014





## Global Support, Weathering Exposure Sites & Laboratories

### ■ Corporate Offices

Chicago, Illinois USA ■ Linsengericht, Germany ■ Shanghai, China ■ São Paulo, Brazil  
Élancourt, France ■ Mörfelden-Walldorf, Germany ■ Bangalore, India ■ Leicester, United Kingdom

### ● Outdoor Exposure Sites & Laboratories

Miami, Florida USA • Phoenix, Arizona USA • Sanary, France • Chicago, Illinois USA • Duisburg, Germany • Leicester, United Kingdom  
Hoek van Holland, The Netherlands • Chennai, India • Prescott, Arizona USA • Loveland, Colorado USA • Medina, Ohio USA  
Keys, Florida USA • Jacksonville, Florida USA • Alberta, Michigan USA • Hainan, China • Guangzhou, China  
Seosan, Korea • Miyakojima, Okinawa, Japan • Choshi, Japan • Kirishima, Japan  
Singapore • Melbourne, Australia • Townsville, Australia • Novorossiysk, Russia  
Gelendzhik, Russia • Moscow, Russia

### ▲ Local Sales & Service Support

To contact your local Atlas Sales representative please visit <http://atlas-mts.com/contact/local-representatives/>

For general inquiries please contact us at [atlas.info@ametec.com](mailto:atlas.info@ametec.com)

[www.atlas-mts.com](http://www.atlas-mts.com)



# Real Weathering Test Solutions

*DEPLOYING PRECISION AND SPEED FOR REAL-WORLD RESULTS*



**AZTEST**  
*arizona desert testing llc*



# Welcome

to Arizona Desert Testing, LLC (AZTEST),  
where capability, climate and client service  
deliver **rapid** and **accurate** weathering test results.

From accelerated to natural, exterior to interior, our range of weathering solutions provide data-driven and empirical findings to evaluate product and material performance.

It is a fact that time and the elements take their toll on products;  
ensure yours pass the test with our spectrum of weathering services.



data generation

precise monitoring

extreme conditions : ideal environment

scientific method

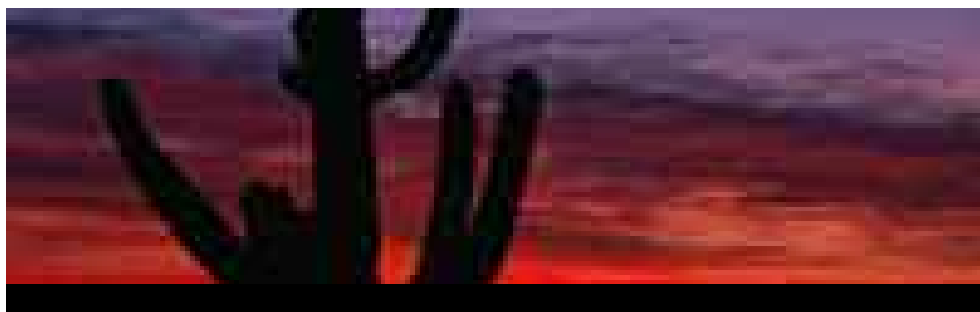

ANALYZING  
 PRODUCT PERFORMANCE  
 OVER TIME IS KEY  
 TO ITS SUCCESS

---

ACCELERATE YOUR RESULTS  
 WITH AZTEST SERVICES

The Arizona desert is an ideal environment for weathering studies. Blistering heat, extreme aridity and near-constant sunshine combine to create a virtually unmatched outdoor laboratory for benchmarking product durability under harsh conditions.

## CONTENTS

<p>ACUVEX®          exterior materials          accelerated weathering ..... 2          proprietary testing services that speed the effects of exposure</p>	<p>AZTEST          complete service suite .....14</p>
<p>AZTEST® ENCLOSURES          for automotive interior materials .....6          testing to gauge interior product reactions to various heat,          humidity, and light conditions</p>	<p>AZTEST          online access and accreditations ..... 15</p>
<p>NATURAL OUTDOOR WEATHERING          testing that measures the effect          of climatic forces ..... 10</p>	<p>HOW TO ORDER ..... 16</p>

high irradiance : accelerated weathering

# ACUVEX



## ACUVEX® for exterior materials

AZTEST's proprietary ACUVEX® for Exterior Materials—Accurate Controlled Ultra Violet Exposure—is an engineered solution that accelerates the effects of material weathering. Its innovative design concentrates sunlight for maximum intensity and measures the related effects on materials.

### HOW ACUVEX WORKS

Each ACUVEX tracker contains 10 specular—highly reflective—mirrors that focus sunlight onto an air-cooled specimen area as required by ASTM G90—**Standard Practice for Performing Accelerated Outdoor Weathering Using Concentrated Natural Sunlight**. Specimens face the mirrors and are mounted upside down onto a specimen target area. Tracker units consist of two ACUVEX test machines mounted on a single tracker, which moves in azimuth (rotation) and elevation to keep the specimen area in focus. Temperatures are maintained by a fan blowing ambient air over the specimen surfaces.

Because of AZTEST's technology and the desert climate, ACUVEX specimens receive about five times more ultraviolet radiation in a year as compared to a southern Florida outdoor exposure.

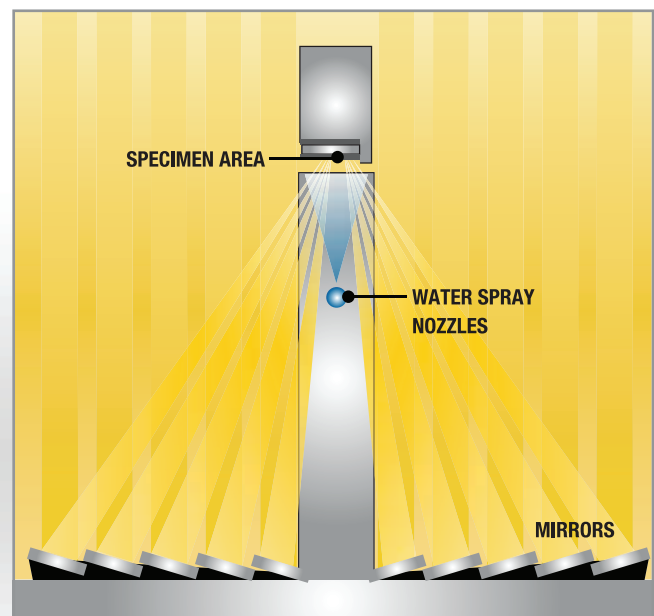



## HOW ACUVEX® TESTS WATER EFFECTS

High-purity water sprays are used to simulate the effects of more humid climates like Florida. The water must contain less than 1.0 ppm TDS (total dissolved solids) and less than 0.2 ppm silica to comply with ASTM G90. ACUVEX spray cycles are shown below:

SPRAY CYCLE	DESCRIPTION
CYCLE 1*	8-minute water sprays every hour during the day with three 8-minute water sprays at night
CYCLE 2*	No water sprays
CYCLE 3*	3-minute water sprays every 15 minutes at night
AZTEST Extended	8-minute water sprays every hour during the day with 3-minute water sprays every 15 minutes at night

\*As listed in ASTM G90

## ACUVEX NATURAL SUNLIGHT

The graph depicts the relative spectrum of natural sunlight compared to ACUVEX. When contrasted with other accelerated weathering test methods, ACUVEX—which complies with ASTM G90—provides the closest match to natural sunlight in ultraviolet terms.

This graph portrays the absolute spectrum of natural sunlight compared to ACUVEX. With the ACUVEX unit, radiation intensity at the specimen surface is much greater than with natural sunlight exposure—providing faster tests.

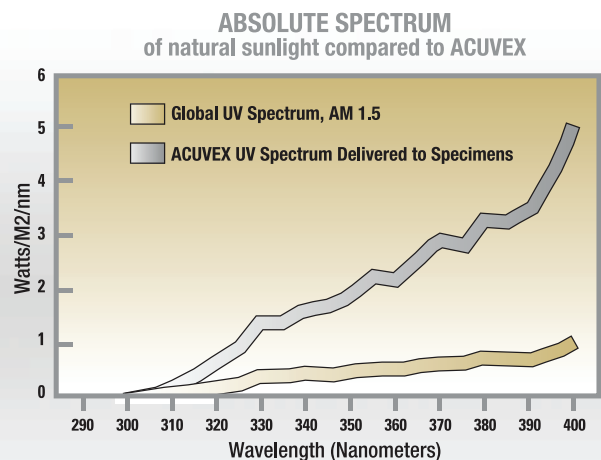
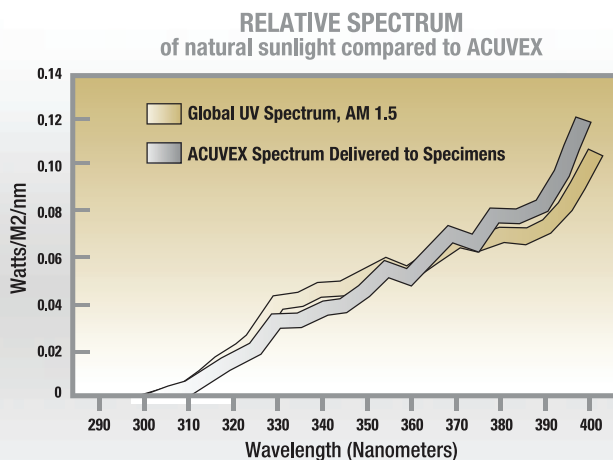

# continuous monitoring

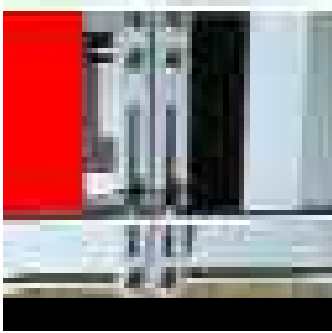

## HOW ACUVEX® CONTROLS AND CAPTURES DATA

Each ACUVEX tracker in the exposure field contains a dedicated onboard computer to control all operation phases, powered by a DC power supply with battery backup. Totally automatic, trackers safely shut down

during power outages until power returns. Each tracker's computer receives input from solar cells and turns on motors to automatically keep

specimens in focus during the day. Other automatic functions include controlling water sprays, switching tracking on and off, and continuously monitoring machine operation.

At AZTEST, our ACUVEX trackers, field weather station, and office computers are connected via a dedicated network. Emergency conditions are reported to office computers, facilitating fast repairs to minimize downtime. Conditions recorded at each test machine are archived to provide a history of exposure conditions. Each ACUVEX tracker has a black and white panel thermometer (as shown at left) mounted in the specimen area alongside test specimens. These are used to monitor machine operations and record exposure-test history.

## HOW ACUVEX SUPPORTS DIVERSE TESTING REQUIREMENTS

Specimens generally are flat with a maximum dimension of 15 cm, (6 in), along one edge. A typical specimen size is 7.5 x 13 cm (3 x 5 in). However, many sizes can be accommodated as long as one dimension does not exceed 15 cm (6 in). Specimens larger than 15 cm (6 in) can often be accommodated with special mounting.

Specimen thickness is usually 3 mm (1/8 in) or less, but thicker specimens can be accommodated with special mounting. Specimens are mounted unbacked, which allows both front and back surfaces to be cooled; however, backed mounting can be used to provide higher specimen temperatures.



## HOW TO ESTIMATE TEST TIME AND COST

Each product's testing is as unique as its profile—to best estimate cost and duration of a specific ACUVEX test exposure, go to:

[www.aztest.com/acucal](http://www.aztest.com/acucal)

This online calculator will provide a close assessment of your requirements as shown below:



# tracking specimen monitoring

## ASTM D5722/ SOAK-FREEZE-THAW TESTING

To test pre-finished hardboard and simulate Midwestern US climates, ASTM Committee D01.52 developed test procedure ASTM D5722, "Performing Accelerated Outdoor Weathering of Factory-Coated Embossed Hardboard Using Concentrated Natural Sunlight and a Soak-Freeze-Thaw Procedure."



Testing subjects samples to a series of daily soak-freeze-thaw cycles that include:

1. Daily exposure using ASTM G90 Cycle 1
2. A one-hour soak using de-ionized water
3. A 12-hour freeze at or near  $-18^{\circ}\text{C}$  ( $0^{\circ}\text{F}$ )
4. A one-hour thaw under ambient conditions

The cycle pattern was chosen because of its good correlation to field failures in climates with freeze-thaw cycles.

### TEST STANDARDS

—  
ACUVEX COMPLIES WITH  
THE FOLLOWING NATIONAL  
AND INTERNATIONAL TEST  
STANDARDS:

ASTM G90  
ASTM D4364  
ASTM D5722  
ASTM D4141  
SAE J1961  
ISO 877

Contact AZTEST Customer Service at  
[wsales@aztest.com](mailto:wsales@aztest.com) for more information  
on how AZTEST can meet  
your specific test requirements.

accelerated weathering : real-world accuracy



## AZTEST® Enclosures

for automotive interior parts and materials

AZTEST Enclosures for Automotive Interior Materials provide vital data and real-world results for interior weathering performance. Automotive interior materials can reach soaring temperatures—exceeding 110° C (230° F) on a summer day in Arizona. Heat and the altered light spectrum from window glass, significantly affects interiors. Add in time, and the effects are both measurable and dramatic.

AZTEST's accelerated weathering test cabinets simulate vehicle interiors and are adjusted to create specific conditions to analyze product performance. AZTEST offers approximately 300 test cabinets ideally suited for evaluating the weatherability of automotive interior materials. In addition, AZTEST is the solar-exposure laboratory for GM interior validation testing and meets automotive standards that include GMW3417, GM2617M, and FORD DVM0020.

### HOW AZTEST ENCLOSURES WORK

Enclosures are sealed, under-glass test fixtures designed with temperature-limiting fans to control the maximum black panel temperature. Black-panel temperature is regulated by a black sensor, which continuously monitors temperatures. As sunlight enters the enclosure, the temperatures of both the cabinet and specimens rise. If the preset temperature is exceeded, recirculating fans automatically cool the interior. Temperatures generally are set in a range from 85° C to 110° C.

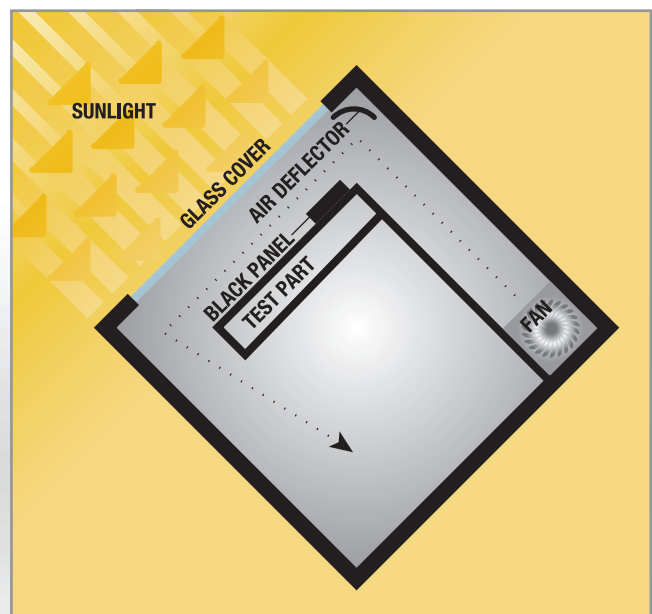

# interiors - automotive

## HOW AZTEST® ENCLOSURES WORK—continued

Standard test cabinets placed on sun-tracking mounts follow the sun in azimuth (rotation) to accelerate the weathering process. Enclosures generally are set at a fixed tilt angle (usually 51 degrees from the horizontal) and tracked as they follow the sun in azimuth. This approach provides more solar radiation and faster tests compared to fixed-angle exposures. Plus, azimuth tracking reduces test times without compromising test accuracy—representing a fast and economical alternative to xenon-arc weathering tests.

## TEMPERATURE-NORMALIZED RADIATION

AZTEST deploys a unique methodology to normalize solar radiant exposure based on temperature. As the sensors measure internal temperatures, TNR (Temperature Normalized Radiation) is calculated with the following equation:

$$TNR = \sum_{\text{start}}^{\text{end}} R * e^{(13.643 - [5000 / (T + 273.15)])}$$

This technique minimizes differences for tests run at different times of the year. For a detailed description of this equation, go to [www.aztest.com](http://www.aztest.com).

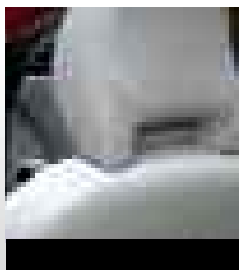

## HOW AZTEST ENCLOSURES SUPPORT DIVERSE TESTING REQUIREMENTS

Two types of specimens are evaluated in the test enclosures—small, flat automotive interior trim specimens and full-size automotive interior parts, including instrument panels, door panels, fabrics, leather, seat cushions, package trays, seat belts, and steering wheels.

All specimens are mounted to within 50 to 100 mm (2 in to 4 in) from the glass cover. To test in accordance with GMW 3417 and GM9538P, the glass covers are either clear tempered or clear laminated, depending on the test component's location in the vehicle.

# automatic sensors

## ADVANCED FEATURES

Every enclosure in the test field is monitored by dedicated onboard computers that control all phases of operation. Each is powered by a DC power supply. Totally automatic, enclosures safely shut down during power outages until power returns. Each enclosure computer receives input from solar cells and turns on motors to automatically keep specimens in focus during the day. Other automatic functions include maintaining black-panel temperatures, switching tracking on and off, and continuously monitoring machine operation.

The AZTEST® enclosures, field weather station, and office computers are connected via a dedicated network. Emergency conditions are reported to office computers, facilitating fast repairs to minimize downtime. Conditions recorded at each test machine are archived to provide a history of exposure conditions.



## HOW TO MEET AUTOMOTIVE VALIDATION STANDARDS

AZTEST is the Solar Exposure Laboratory for performing testing in accordance with GMW 3417 and GM 9538P. For these applications, test enclosures are configured as follows:

- Follow-the-sun operation in azimuth with a fixed altitude tilt angle of 51°
- Circulating fans that switch on when black panel temperature reaches 85°C, 93°C, 102°C, or 110°C, depending on the parts type and location in a vehicle
- Exposure timing based on TNR Langleys (Temperature Normalized Radiation)
- Clear laminated or clear tempered glass cover



## TYPICAL TEST TIMES FOR SELECTED INTERIOR PARTS (based on GM 2617M)

PART	REQUIREMENT	TYPICAL TEST DURATION
Instrument Panel	100,000 TNR Langleys at 102°C	4.5 to 7 months
Door Panel Upper / Armrest	50,000 TNR Langleys at 85°C	4 to 6 months
Door Panel Vertical	5,000 TNR Langleys at 85°C	less than one month
Console (horizontal portion)	30,000 TNR Langleys at 93°C	2 to 3 months
Overhead Parts	10,000 TNR Langleys at 85°C	1 to 1.5 months



accuracy  
real-world results



#### ACCELERATED AZTEST MIRRORED ENCLOSURES

AZTEST® offers Mirrored Enclosures for further acceleration. Developed by personnel at GM's Desert Proving Grounds, mirrored enclosures offer significantly faster acceleration over standard enclosures.

This technique allows specimens to accumulate TNR Langleys or MJ/m<sup>2</sup> nearly two times faster than normal azimuth tracking enclosures. Because of the additional light energy provided to specimens, these enclosures typically are operated only at black-panel temperatures greater than or equal to 102°C. Results on these enclosures are generally accepted by GM for hard plastics.

Contact AZTEST Customer Service at [wsales@aztest.com](mailto:wsales@aztest.com) for more information on how AZTEST can meet your specific test requirements.

# NATURAL

true environmental effects : outdoor exposure

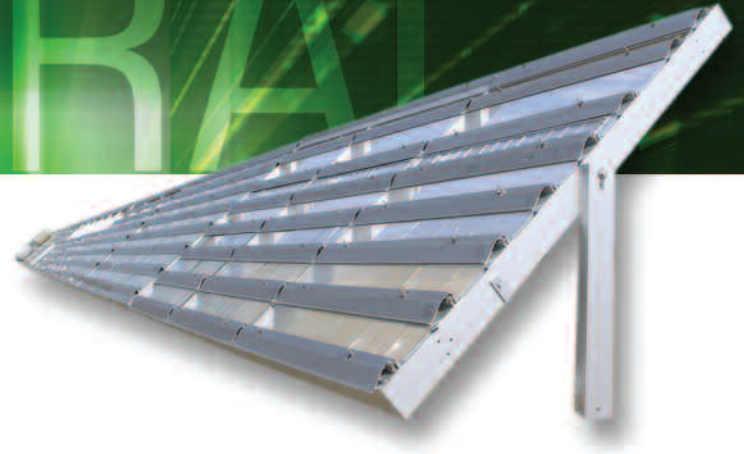

## Natural Outdoor Weathering

AZTEST's desert location offers excellent opportunities for natural weathering evaluations. Extremely hot and dry, the Arizona environment is the standard climatic measurement for any outdoor weathering needs. Natural weathering is the only true benchmark for weathering tests. Although very good, accelerated tests can never exactly simulate reactions to real outdoor settings with their inherent climatic changes. Natural weathering not only tests environmental effects, but also respects environmental integrity—using far less electricity than artificial weathering.

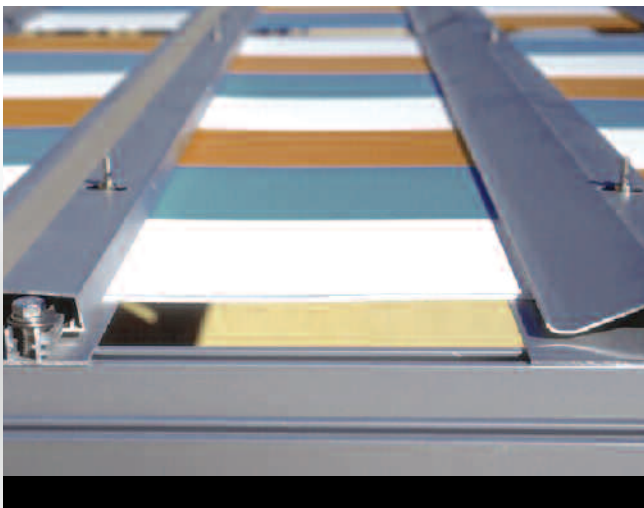

### NATURAL WEATHERING STANDARDS

Our testing procedures meet numerous requirements for outdoor weathering, including these industry standards: ASTM G7, G24, D 1435, D 4141, SAE J576, SAE J1976, GM 9163P, GMW 14873, Ford B1-160, and ISO 877. Outdoor exposure tests are typically performed on aluminum exposure racks capable of handling specimens of various dimensions.

# outdoor weathering

## TYPES OF NATURAL WEATHERING

### Direct Weathering

Direct weathering exposes specimens directly to the elements. Specimens are mounted on aluminum exposure racks capable of handling various dimensions and evaluated per industry standards. Factors that affect exposure findings include specimen backing, orientation and test duration.

### Under Glass Weathering

Under glass weathering specimens are mounted under or behind glass. Specimens usually are samples of test materials used inside a building or automobile. Test materials are exposed in cabinets, which protects them from rainfall while letting sunlight pass through a sheet of glass. The glass filters the sunlight, removing (at a minimum) shorter ultraviolet wavelengths in solar radiation. Enclosures are either well-ventilated or sealed, depending on customer requirements. Some of the factors that affect exposure findings include glass type, specimen backing, orientation, and test duration.

### Backing

Backing has a direct effect upon material temperature. The common backing types are:

BACKING TYPE	TYPICAL USE
UNBACKED	Coil coatings, sign material, automotive
BACKED	Siding, roofing, building products, automotive
EXPANDED METAL	Automotive
BLACK BOX	Automotive

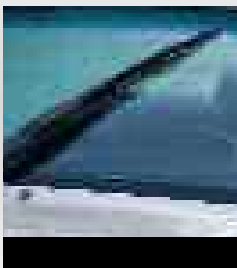

# backing direct exposure under glass

## EXPOSURE ANGLES

Specimens can be exposed at any angle facing south. The following table lists the most common exposure angles used in weathering tests:

ANGLE*	TYPICAL APPLICATION
5°	Most automotive specifications
34°	Same as site latitude: generally the most accumulated radiant exposure in a typical year among the common exposure angles
45°	Most popular exposure angle
90°	Siding and other materials used at vertical orientation
Variable 14° – 34° – 54°	Maximizes radiant exposure with four angle changes per year with an overall increase over 34° of about 15 %

\* Measured from the horizontal, facing south

## EXPOSURE DURATION

The duration of weathering is based on elapsed time (days, weeks, months, or years), or based on accumulated radiant exposure—either total (all wavelengths) or ultraviolet. Periodic inspections, measurements and/or returns are recommended.

## FLORIDA WEATHERING

AZTEST can arrange for exposure tests in Florida and other locations. Contact [wsales@aztest](mailto:wsales@aztest) for more information.

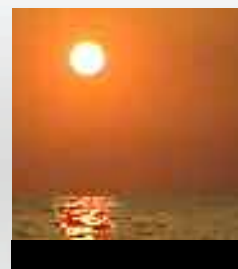
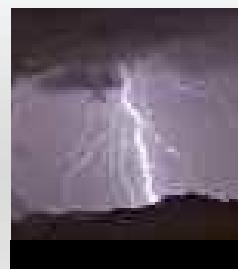
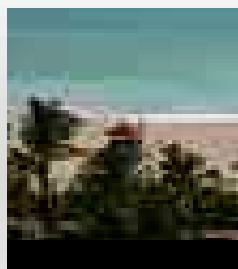



### SAE J 576 TESTING

AZTEST provides SAE J576 compliant testing services to meet automotive plastic lens material requirements as required by the Federal Motor Vehicle Safety Standard No. 571.108.

SAE J576 also allows accelerated testing in accordance with ASTM D 4364. This standard is based on ASTM Standard G 90, "Standard Practice for Performing Accelerated Outdoor Weathering of Nonmetallic Materials Using Concentrated Natural Sunlight."

Accelerated and Natural Arizona and Florida Weathering tests are available, including all the required instrumental measurement and visual evaluations.

Federal Motor Vehicle Safety Standard No. 571.108, Lamps, Reflective Devices, and Associated Equipment requires the following tests:

TEST	REQUIREMENT
Material Thickness	Required thickness 1.6 mm, 2.3 mm, 3.2 mm, 6.4 mm
Heat Test	2 hours in circulating oven at $79 \pm 3^\circ \text{C}$
Outdoor Weathering	3 years Arizona and Florida — SAE J576
Haze	After weathering, haze cannot exceed 30% as measured by ASTM D1003 for plastic materials used for outer lenses; 7% for plastic materials used as reflex reflectors or for lenses used in front of reflex reflectors.
Luminous Transmittance	After weathering, the luminous transmittance measured in accordance with ASTM E308 shall not have changed more than 25% compared to unexposed measurements.
Color	Must meet SAE J578 color specification before and after weathering
Visual Evaluations	After weathering, must not have color bleeding, delamination, crazing, or cracking. Materials used for reflex reflectors and for materials used in front of reflex materials must not have surface deterioration or dimensional changes.
Minimum number of specimens per material, coating and color type	20 specimens (Five of each thickness).



As an A2LA and AMECA accredited lab, AZTEST can perform all weathering tests required by AMECA and SAE specifications related to automotive lighting lens materials.

diverse : flexible : custom



## AZTEST

complete service suite

Recognizing the diversity of customer testing goals, AZTEST is pleased to offer testing and evaluation services that span numerous color measurement requirements, visual inspection data, and special project objectives.

### COLOR AND GLOSS MEASUREMENTS

AZTEST performs color measurements using a Hunterlab Ultrascan XE spectrophotometer. This instrument features:

- Dual beam optics
- Integrating sphere
- Pulsed Xenon light source
- Capability to measure transparent, translucent, and opaque materials
- Small area (6 mm - 1/4 inch) optional view area
- Improved accuracy and repeatability
- Integrated color measurement software

Typically, color measurements are first performed prior to exposure and then re-assessed after weathering exposure to determine color change. AZTEST can perform color measurements with any common illuminant scale and observer, as well as report measurements using standard scales, including XYZ, CIE Lab, and Hunter Lab. Color measurements also can be performed using portable X-Rite spectrophotometers.

In addition, AZTEST performs gloss measurements using Byk-Gardner and Hunterlab gloss meters with available geometries of 20°, 60° and 85°.

### INSPECTIONS

AZTEST visual inspections are performed in accordance with ASTM and ISO standards. The following criteria (if appropriate) can be included in inspection reports:

- General Appearance
- Checking/Cracking
- Chalking (ASTM and ISO)
- Blistering
- Erosion
- Dirt Retention
- Flaking/Scaling

Digital photography is available as part of AZTEST inspection services.

### SPECIAL PROJECTS

AZTEST is well-versed in conducting special projects that include the following:

- Temperature measurements
- Custom facility design such as:
  - Test Cabinets
  - Solar Simulators
  - Accelerated Weathering Facilities
  - Conventional Test Racks
- Driving evaluations
- Software development



## Internet Data Access

AZTEST clients have the option of password-protected Internet access to their test data through our secure Web site. Clients can perform the following operations:

- Get current “real-time” program status
- View results from color gloss and visual inspection evaluations
- View scanned documents
- View digital start and end of test photographs
- Reset passwords

Client confidentiality of data is protected through our SSL (secure socket layer) Web site and password-protected system.



Testing Certificate # 1507.01

## ISO 17025 Accreditation

AZTEST’s Wittmann location is fully accredited by A2LA (American Association for Laboratory Accreditation) to ISO Guide 17025 (Certificate # 1507.01). For a copy of our A2LA Scope of Accreditation, go to [www.aztest.com](http://www.aztest.com). AZTEST also is accredited by AMECA, the Automotive Manufacturers Equipment Compliance Agency for testing automotive lighting to FMVSS 571.108 and SAE J576 .

convenient : quick : secure

# ORDER

## How To Order

Contact AZTEST Customer Service at [wsales@aztest.com](mailto:wsales@aztest.com) for more information on how AZTEST can meet your specific test requirements. The sales team will provide guidance on how to create a test, ship your samples and set parameters to evaluate products.

### TO CREATE AN ORDER:

- Go to [www.aztest.com](http://www.aztest.com)
- Click on "Download" at the top of the home page
- Select "Order Forms" from the drop down menu
- Select order form format
- Complete and submit to [wsales@aztest.com](mailto:wsales@aztest.com)

### GUIDELINES FOR ORDERING, PACKING AND SHIPPING\*:

#### **From US locations—**

- Carefully package test samples for shipment
- Non-fabric specimens should be wrapped in a soft paper product (we recommend Kimtech Kimwipes Delicate Task Wipers)
- Do not use newspaper
- Wrap entire package in bubble wrap and secure with tape
- Place package in sturdy box or container and fill gaps with packing material

#### **From international locations—**

- Follow US location packaging instructions above
- Complete a Commercial Invoice to accompany samples
- Assign a \$1.00 value on shipping documents (we recommend sample description as follows: "Test Samples. No Commercial Value")

\*INSTRUCTIONS ALSO AVAILABLE AT [www.AZTEST.COM](http://www.AZTEST.COM)

### SEND PACKAGED SPECIMENS, ORDER FORM (OPTIONAL) AND PURCHASE ORDER TO:

**Arizona Desert Testing LLC**  
21212 West Patton Road  
Wittmann, Arizona 85361  
USA

### To contact AZTEST:

call: +1-623-388-9500  
fax: +1-623-388-9007  
e-mail: [wsales@aztest.com](mailto:wsales@aztest.com)  
visit: [www.aztest.com](http://www.aztest.com)

write: 21212 West Patton Road  
Wittmann, Arizona 85361  
USA

A photograph of a desert landscape featuring sand dunes in the foreground and a bright sun in a hazy, overcast sky. The sun is positioned in the lower right quadrant, creating a lens flare effect. The overall color palette is muted, with various shades of gray and beige.

**AZTEST**

*arizona desert testing llc*





# Q-Lab Test Services

---

- ▶ Florida & Arizona Outdoor Exposures
- ▶ Accelerated Laboratory Testing
- ▶ Evaluations



# Weathering & Outdoor Climatic Testing

---

If you're concerned about your product's appearance or functional performance in the outdoor environment, you're not alone. Sunlight, heat, and moisture cause billions of dollars in product damage every year. A proper weathering testing program can help you anticipate and prevent a variety of potential product failures, meet durability specifications, and preserve your reputation for quality.

**Will your product last outdoors? Don't guess when you can test!**

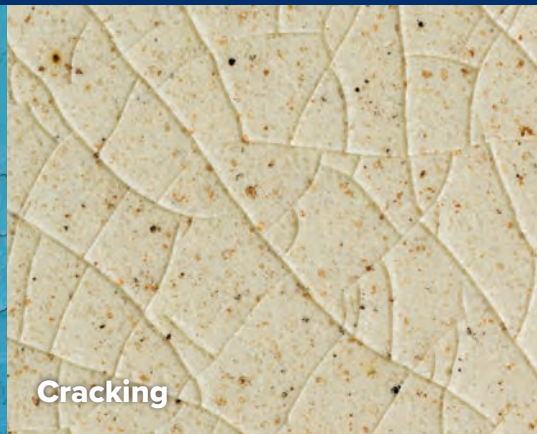



## WHY TEST?

### Reliable weathering and corrosion data can help you:

- > Avoid unexpected product failures
- > Make the best material selection decisions
- > Validate new or less-expensive materials or additives
- > Improve your competitive advantage
- > Warranty your product's lifetime with confidence

Natural outdoor weathering and corrosion testing give the most realistic prediction of product performance. Accelerated testing, available both outdoors and in the laboratory, gives faster results but with some uncertainty about its accuracy. Many companies combine both approaches to ensure reliable results in the shortest time possible.

## WHY CHOOSE Q-LAB?

### Experienced and Reliable

Q-Lab provides the highest-quality weathering testing services. Our first natural weathering site opened in 1959. Today, our scientists and engineers participate and offer leadership in ISO, ASTM, IEC, GB, and numerous other professional organizations in creating standardized test methods and procedures.

### Instant Credibility

When Q-Lab does your testing, the results have instant credibility with your customers and colleagues. Q-Lab conducts all exposure tests and evaluations in accordance with appropriate test methods from ASTM, ISO, BSI, DIN, JIS, SAE, GB, and other recognized organizations and is accredited by AMECA and AAMA.

### Cost-Effective

Q-Lab's state-of-the-art test services are available at a surprisingly affordable price. In many cases, it is less costly to test with Q-Lab than to set up and run tests yourself.

### Best Test Sites, Best Technology

South Florida and Arizona, where Q-Lab does most of its outdoor testing, have been recognized for over a century as harsh climates for product testing. If your products perform well in these benchmark locations, they will perform well just about anywhere. Q-Lab uses the most trusted accelerated weathering and corrosion technologies, used by thousands of companies in dozens of industries.



# Natural Outdoor Testing

**Location is everything.** About one hundred years ago, companies in the paint and automotive industries realized that environmental conditions in South Florida and the Arizona desert were the harshest on their products. Several companies operated their own test sites in these locations, and they used what they learned to make their products durable enough to ensure generations of satisfied customers. Today, much of this testing has been consolidated at Q-Lab's sites in Florida and Arizona. Companies around the globe trust Q-Lab to perform their outdoor product testing.

## FLORIDA

The subtropical climate of the Miami area has the perfect year-round combination of abundant sunlight, warm temperatures, and plentiful water. Sunshine during the summer months in Miami is quite similar to that of northern temperate regions. However, in the winter the difference is dramatic. The key point is that it is the same sun—just more of it, and for a longer duration each year. The same holds true for temperature, rainfall, dew, and humidity.

The result of this perfect combination of environmental factors is that exposures at Q-Lab Florida are accelerated compared to temperate climates. One year of Florida sunshine can produce the same weathering effects on materials as several years of weathering in most major markets around the world. Specimens that can withstand the sunlight, heat, and water in south Florida can be expected to be durable in most locations around the world.

## SOUTH FLORIDA IS PERFECT FOR TESTING:

- > Sunlight (UV) stability
- > Moisture sensitivity
- > Mildew/mold resistance
- > Surface erosion
- > High-temperature resistance
- > Thermal shock response
- > Corrosion behavior
- > Moisture ingress
- > Acid rain resistance

## THE GLOBAL BENCHMARK

Q-Lab Florida has more specimens on test than any other outdoor weathering facility in the world.





## DESERT TESTING

Arizona features even hotter temperatures and higher levels of sunlight than Florida.

## ARIZONA

Arizona's desert climate is characterized by intense sunlight, very high temperatures, minimal rainfall, and very low humidity. Arizona desert exposures provide a different – in some ways harsher – exposure environment than Florida subtropical tests. Compared with Florida, Arizona is much hotter and receives about 15-20% more annual total solar and UV energy. Arizona experiences large day to night temperature variations, about 17 °C (31 °F) on average. Arizona receives little annual rainfall and has low atmospheric moisture overall. Specimens tested in the Arizona desert can be expected to have superior resistance to sunshine and elevated temperatures.

## ARIZONA DESERT IS PERFECT FOR TESTING:

- > Sunlight (UV) stability
- > Heat aging effects
- > Thermal expansion stress resistance
- > Heat deflection and distortion
- > Material durability in low humidity environments

## OHIO

Northeast Ohio has a Northern Temperate climate, meaning it experiences four true seasons during the year. Outdoor specimens are subject to a range of exposures to UV light, temperature, and water, including regular freeze/thaw cycles during the winter.

Although Northeast Ohio testing will generally not attain the acceleration of natural outdoor testing in Florida or Arizona, it does deliver conditions experienced by much of the population of the United States and the rest of the world.

Some industries include a benchmark Northern Temperate climate in their certification programs, in addition to Florida and Arizona, to ensure a fully comprehensive program for natural weathering. Ohio is ideal for meeting these requirements.





# Accelerated Laboratory Testing

Q-Lab offers a full range of accelerated laboratory weathering and corrosion testing services at our fully-equipped facilities in Florida and Germany. Q-Lab can perform most testing that utilizes xenon arc, fluorescent UV, salt spray, or cyclic corrosion chambers. Contract testing at Q-Lab is an ideal solution for companies that:

- > Have a short-term need for testing but aren't ready to invest in facilities and equipment
- > Need additional testing capacity that the in-house lab can't accommodate
- > Have a special project with a new test cycle that can't be performed in-house
- > Need third-party verification of test results

## STANDARD & CUSTOM EXPOSURES

Tests and evaluations are performed to appropriate ASTM, ISO, EN, DIN, JIS, SAE, GB, AATCC, or other standard procedures.

Visit [Q-Lab.com/standards](http://Q-Lab.com/standards) or contact Q-Lab to discuss a particular standard.

We can also perform custom exposures to meet your individual testing needs. **More on page 13.**

## TWO LABS, ONE STANDARD OF QUALITY

- > Homestead, Florida USA
- > Saarbrücken, Germany

Both locations follow the ISO 17025 accredited Quality System, ensuring the best care for your projects.



**Homestead, Florida USA**



**Saarbrücken, Germany**



## RAPID RESULTS

Xenon arc test chambers are used to test colorants in paints and plastics.

## TYPES OF ACCELERATED TESTS



### XENON ARC WEATHERING

For weathering tests that require full sunlight simulation, the **Q-SUN** xenon arc weathering chamber can perform a variety of methods from the automotive, textile, building material, paint, plastics, personal care, or other industries. Xenon arc instruments are usually the best choice for applications where color change is the primary failure mode of concern.



### FLUORESCENT UV WEATHERING

When changes to physical properties of polymeric materials are the concern, the **QUV** accelerated weathering tester is an effective tool for comparative testing. Fluorescent UV lamps match the most damaging portion of the sunlight spectrum (UVA and UVB), reproduce degradation from germicidal treatments (UVC), or simulate indoor environments (Cool White).



### SALT SPRAY/ CYCLIC CORROSION

**Q-FOG** cyclic corrosion chambers can perform any test from simple salt spray to tests with precise control of RH and moisture transitions, which is required by most OEM automotive standards. In addition, certain models can also perform demanding modern test protocols like CASS and JASO M609.



# Q-TRAC Natural Sunlight Concentrator Testing

**Faster test, natural environment.** Accelerated outdoor materials testing using a Q-TRAC natural sunlight concentrator delivers the benefits of testing in a natural outdoor environment while at the same time amplifying the sunlight and heat delivered to specimens. This testing is especially useful for highly-durable materials with long expected lifetimes.

## SUPER-FAST RESULTS FROM NATURAL SUNLIGHT

The Q-TRAC delivers the same amount of damaging ultraviolet energy in just one year as specimens would experience in five years of Florida sunlight. Like other accelerated tests, sunlight concentrator testing allows products to be brought to market faster, but the Q-TRAC uses natural sunlight to reduce further the risk of generating erroneous test results. In this way, the Q-TRAC delivers dual benefits – the realism of natural exposures and the speed of accelerated laboratory tests.

## Q-TRAC IS PERFECT FOR TESTING:

- > Roofing
- > Coil coatings
- > Fluoropolymers
- > Geosynthetics
- > Powder coatings
- > Building materials
- > Industrial coatings
- > Hardboard coatings

## ONLY IN ARIZONA

Q-TRAC testing requires a high proportion of direct beam sunlight and low cloud cover that exists only in very dry environments.



## ENHANCED SUNLIGHT WITH CONCENTRATING MIRRORS

The Q-TRAC system uses an array of 10 flat mirrors to reflect and concentrate natural sunlight onto the test specimens. It further maximizes the exposure by automatically tracking the sun throughout the day in both azimuth (horizontal) and elevation (vertical).

## Q-TRAC WATER SPRAY & SPECIAL APPLICATIONS

Water spray during the night time can simulate the time of wetness experienced in Florida, and during the day it can simulate thermal shock associated with rain bursts. During night-time wetting, specimens are oriented facing upward to give increased wetness and realism compared to original natural sunlight concentrator testing. Q-Lab also offers temperature-controlled Q-TRAC testing for more heat-sensitive specimens.

Several standardized cycles—including desert, freeze/thaw, and spray are available to test different materials and end-use application. Standards include:

- > ASTM G90
- > ASTM D4141
- > ASTM D4364
- > ASTM D5105
- > ASTM D5722
- > SAE J1961
- > SAE J576
- > ISO 877-3
- > AAMA 623, 624 and 625

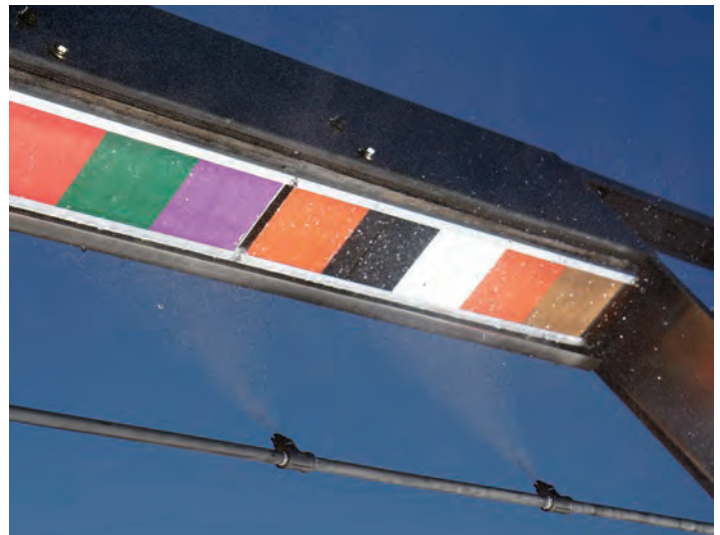
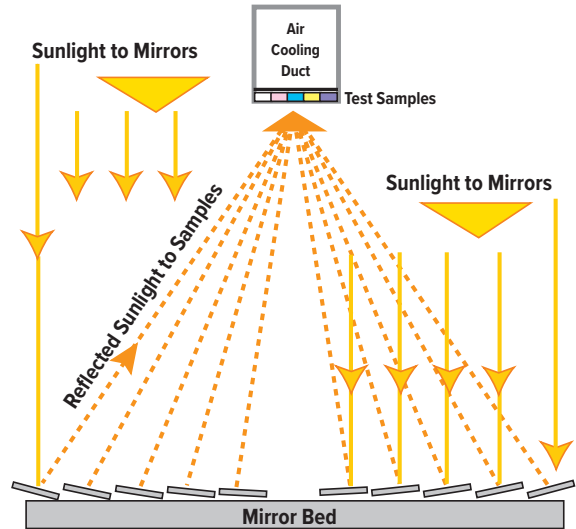

# Automotive Interior Testing

**Accelerated testing to simulate behind-glass environments.** Interior components in automobiles and other behind-glass environments can experience higher temperatures than materials in service outdoors. AIM box testing delivers high temperatures in combination with natural sunlight behind window glass for fast, realistic testing.

## AIM BOX

An Automotive Interior Materials (AIM) box is an under-glass enclosure that simulates the sunlight and heat found inside an automobile. Although this technology was developed for the automotive industry, it can be very effective for many applications where glass-filtered sunlight and heat are important stressors, such as building window assemblies and electrical enclosures.

Key test standards for AIM box testing include GMW 14873, GMW 16717, GMW 3417, GM 2617M, GM 3619M, GM 7454M, GM 7455M, GM 9538P, Ford DVM 0020, and ASTM G201.

## DEGRADATION MODES PRODUCED IN AIM BOX TESTING:

- > Color change
- > Cracking
- > Peeling
- > Oxidation
- > Heat deflection
- > Tackiness

## REALISTIC SIMULATION

Testing automotive interiors can be different from testing other materials because air temperatures inside a vehicle can far exceed the temperature outside it. Materials can reach 100 °C or more in warmer climates. Furthermore, the light that reaches internal components is filtered by automotive glass, making it different from natural outdoor sunlight.

The AIM box uses tempered glass - clear or laminated - to simulate the sunlight spectrum experienced inside a car. In addition, a black panel thermometer continuously monitors the environment inside the box. A cooling fan and curtain are used to ensure that specimens are maintained at precise and realistic temperatures.

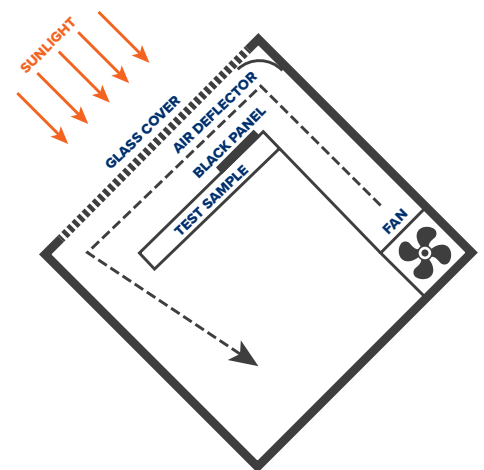





### **HIGH TEMPERATURE TESTING**

Automotive instrument and dashboard panels are commonly tested in AIM boxes.

### **ACCELERATION**

The AIM box in Arizona can perform precision azimuth tracking of the sun throughout the day. This boosts the total amount of solar radiation reaching the specimens for faster results without sacrificing accuracy.

### **TRUE AIM BOX**

To increase the total amount of solar radiation exposure, Q-Lab's proprietary new TRUE (Tracking Reflecting Ultra Exposure) AIM box uses highly reflective mirrors and dual-axis tracking (azimuth and elevation) to focus more sunlight into the box interior. This technique approximately doubles the total sunlight received every day.



# Standard Outdoor Exposures

---

**True benchmarking via standardized testing.** Natural outdoor testing according to international test standards gives improved consistency of results from test to test. Having a library of outdoor test data according to recognized test standards gives the best estimate for a product's service life and serves as an excellent basis for comparison to accelerated laboratory testing.

## DIRECT EXPOSURE (ASTM G7, ASTM D1435)

Specimens can be securely mounted at a variety of angles for direct exposure to the sun. Various backing techniques are available to simulate the thermal environment of the specimen's intended service application. Plywood backing raises temperatures, while open- or mesh-backed specimens receive maximum natural air flow for cooler temperatures.



## UNDER GLASS (ASTM G24, ISO 877-2)

These exposures are used to test interior-use materials, such as textiles and printing inks. Specimens are behind 3 mm window glass which will filter out short-wavelength (UVB) light. Exposures are typically at a 45° or 5° angle from horizontal.



## BLACK BOX (ASTM D4141, GMW 14873)

These tests reproduce conditions found on the horizontal surfaces of a vehicle, including higher temperatures and longer wet times. Under glass black box exposures are used to test automotive interior materials or other applications that experience similar conditions.



*Other standard outdoor exposure test methods are available, including salt-accelerated, outdoor acid etch, and mildew-enhanced weathering.*

# Custom Tests & Special Projects

If you need a specialized test for a component, assembly, or complete product, Q-Lab can customize a test program to identify any problem areas quickly. Do you need to measure the temperature profile of multiple areas of your product throughout the day? Or design a test that accurately simulates your product's end use? Whatever your need, our experts can design a customized test solution to fit your budget.

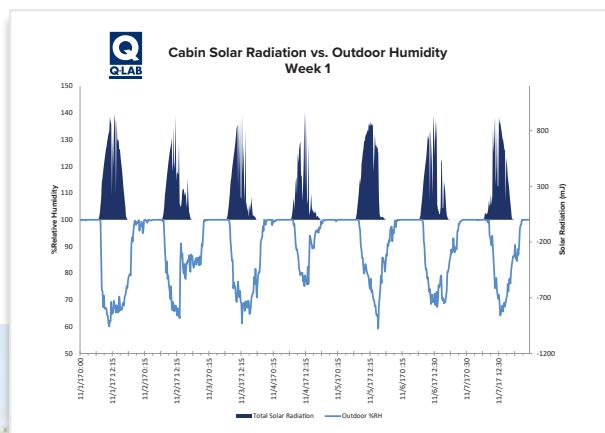

Outdoor weathering testing in a replicated end use environment, like the shed shown above, can demonstrate interactions between components and give a more realistic representation of outdoor product durability.

## DETAILED DATA ACQUISITION

Q-Lab can instrument your product to capture the data most important to you, and we always take care to protect confidentiality.



# Evaluations & Physical Testing

---

Exposing your products or materials is only half of the equation. Measuring how they degrade over time is the other half. Q-Lab's engineers and technicians are worldwide experts at identifying and quantifying how your materials change when exposed to weathering or corrosion tests. We have many tools at our disposal to tell you nearly everything you need to know about your product's performance.

## VISUAL EVALUATIONS

Visual evaluations detail all defects observed, such as cracking/checking, blistering, chalking, dirt retention, flaking, mildew growth, surface rust, or color change, according to standardized rating scales.

Q-Lab technicians are highly trained and experienced experts in the field of evaluation techniques and reporting scales. Many are actively involved in the organizations that create and maintain the standards relied upon by labs around the world.

## COLOR & GLOSS MEASUREMENTS

Instrumental measurements of appearance and surface characteristics include gloss, distinctness of image, and color. These are used in place of or in addition to visual ratings, and are required by many standards. The science of color and appearance measurement can be very complex, and Q-Lab's experts can guide you through your options to ensure you get the correct data for your needs.



Color & Gloss



Mechanical



Photography



## **VISUAL EVALUATIONS**

All visual ratings are made under standard lighting conditions to provide accurate, repeatable results.

## **MECHANICAL TESTS**

Mechanical tests on physical properties are necessary for many products and materials. They include:

- > Drop impact
- > Pencil hardness
- > Tape adhesion
- > Mandrel bend & elongation
- > Tensile strength & elongation
- > Shear & peel adhesion
- > Gravelometer stone chip impact
- > Taber abrasion

## **PHOTOGRAPHY & SPECIAL HANDLING**

A complete test program often includes other special services or handling. Common services include washing, polishing, scribing, and specimen weighing. Q-Lab can also photograph weathering and corrosion changes, which requires special lighting skills and equipment.



## OUR GLOBAL NETWORK

We are committed to provide world-class technical, sales, and repair support in each of the over 60 countries in which we operate. Visit [Q-Lab.com/support](https://www.q-lab.com/support) for contact information specific to your location and inquiry type.

### GLOBAL HEADQUARTERS

WESTLAKE, OH USA  
info@q-lab.com  
+1-440-835-8700

### Q-LAB EUROPE, LTD.

BOLTON, ENGLAND  
info.eu@q-lab.com  
+44-1204-861616

### Q-LAB DEUTSCHLAND GMBH

SAARBRÜCKEN, GERMANY  
info.de@q-lab.com  
+49-681-857470

### Q-LAB CHINA

SHANGHAI, CHINA  
info.cn@q-lab.com  
+86-21-5879-7970

### Q-LAB FLORIDA

HOMESTEAD, FL USA  
testing@q-lab.com  
+1-305-245-5600

### Q-LAB ARIZONA

BUCKEYE, AZ USA  
testing@q-lab.com  
+1-623-386-5140